

Phone Information

Extension Number: _____

Passcode / Voice Mail Access Code: _____

IP Address: _____

MAC Address: _____

Serial Number: _____

REV 1.0

Total Office Solution **TOS 3000**



IP2061 Quick Reference Guide

ICON Voice Networks

8001 Jetstar Drive
Irving, TX 75063
www.iconvn.com

Printed in USA

Part Number: 702405

ICON Voice Networks

Introduction

The IP2061 includes a six-line LCD screen, dial pad, four soft keys, handset, I/O ports, and an integrated three-position desktop pedestal with a wall-mount option. The IP2061 supports Power-over-Ethernet (PoE), but also ships with a 5V/2A power adapter when PoE is not available.

Use the illustrations and tables on the next few pages to familiarize yourself with the IP2061.

IP2061 Front-View

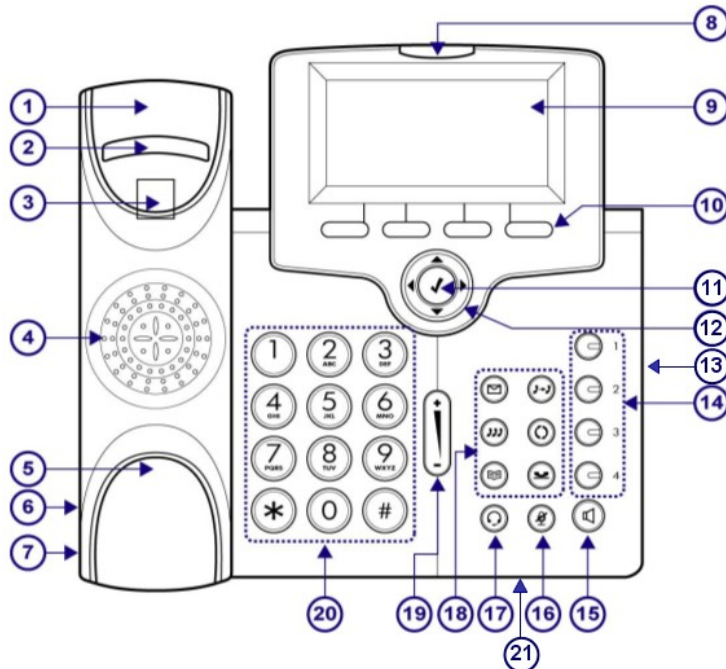

Depending on the TOS 3000 software version and how your phone is programmed feature availability and operation may differ from the instructions in this guide. For more information contact your authorized ICON Voice Networks Dealer.

2. Use the navigation key to select Ring Type and press OK.
3. Use the dial pad to enter a new Ring Type (0-10) and press OK. Use the Backsp soft key to clear the current entry.

Speed Dialing

The Speed Dialing feature lets you store a list of 10 phone numbers that you can easily access using a speed dial number from 0 to 9.

Speed Dialing a Number

1. Press the LCD Menu soft key and use the navigation keys to select Speed Dialing and press the OK.
Or,
if your phone is idle press the navigation key down arrow (▼) to access Speed Dial.
2. Use the navigation keys to scroll through the speed dial list.
3. Press the Dial soft key to dial a number.

Editing your Speed Dial Directory

1. Press the LCD Menu soft key and use the navigation keys to select Speed Dialing, then press OK.
Or,
if your phone is idle press the Navigation key Down arrow (▼) to access Speed Dial.
2. Use the navigation keys to scroll through the speed dial list
3. To add a new number, find an empty position (0-9) and press the Edit soft key. Use the dial pad to enter a new number and press OK.
4. To edit an existing number, find the number (0-9) you want to edit and press the Edit soft key. Use the Backsp soft key to clear the number and use the dial pad to enter a new number and press OK

Phonebook:

The Phonebook feature allows you to store a list of phone numbers for fast dialing. The IP2061 can store up to 200 entries.

Browse the Phonebook

1. Press the Phonebook key.
Or,
press the LCD Menu soft key and use the navigation keys to select Phonebook. Press OK
2. Select Index to browse by phonebook table entry number, select Name to browse by name, select Group to browse by one of four group designations (Family, Friends, Colleague, or VIP). Select None to browse phonebook entries that have not been assigned to a group.
3. Once you have selected a phonebook contact you can press the Dial soft key to call.





Edit the Phonebook









1. Press the Phonebook key.
Or,
press the LCD Menu soft key and use the navigation keys to select Phonebook. Press OK.
2. Select New and press OK.
3. Enter the phone number using the dial pad then press OK.
4. Press the Edit soft key to edit the Name, Ring Type, Group, and press OK.
5. To delete an entry, press the Del soft key to delete that entry.

Ring Type

The IP2061 allows you to select a one of eleven distinctive ring types for your phone. (Default = 0).

1. Press the LCD Menu soft key and use the navigation keys to select Ring Type and press the OK.

No	Part Name	Description
1	Handset Cradle (Top)	For the placement of handset (receiver end).
2	Hook switch	On-hook / off-hook switch.
3	Handset Hook	Secures the handset when the stand is set at 60° or when wall-mounted.
4	Speaker	Provides sound for ringing and hands-free conversation.
5	Handset Cradle (Bottom)	For the placement of handset (transmitter end).
6	Handset Jack	RJ-9 handset jack for connecting the handset cord.
7	Headset Jack	RJ-9 headset jack for connecting a headset.
8	 Message LED	Indicates an incoming call, new voice message, or registration notification.
9	Telephone Display	The six-line backlit LCD displays features such as the time, date, telephone number, caller ID, line/call status, number of messages and soft key menus.
10	 Soft keys	Each of the four soft keys activates the feature option displayed on the bottom line of the LCD. Soft key feature availability is dependent on the state of the telephone.
11	 [✓] OK / Enter Key	Use the √ key to confirm a menu setting or a dialed telephone number.
12	 Navigation Control Keys	The four navigation arrows ◀ ▶ ▲ ▼ allow you to scroll through text and select features on the telephone display.

No	Part Name	Description
13	Extension Dial Module (EDM) Port	The optional EDM connects to the IP2061 and adds 24 programmable keys.
14	 Line Keys (1-4)	Line keys 1-4 can be used for line appearance or programmable features. Line Key In-Use = Green LED. Line Key Not In-Use = No LED.
Fixed Function Keys		
15	 Speaker key	Toggles the speaker (headset if active) on or off. Speaker On = Green LED. Speaker Off = No LED.
16	 Mute key	Toggles mute on or off. Mute On = Red LED. Mute Off = No LED.
17	 Headset key	Activates Headset Mode. Headset On = Green LED. Headset Off = No LED.
18	 Transfer Key	Transfer a call to another station or number.
	 Redial Key	Redial a number from the dialed record menu list.
	 Hold Key	Press the Hold key to place a call on hold or retrieve a held call.
	 Message Key	Press the Message key to access the voice mailbox associated with the station.
	 Conference Key	Press the Conference key to initiate a call conference call after two calls are connected.

receive a busy signal.

Call Forward:

1. Press the LCD Menu soft key and use the navigation keys to select Call Forward and press OK.
2. Scroll to select the call forwarding type you want to activate. Select Always Forward to forward all calls, Busy Forward to forward only busy calls, No Answer Forward to forward only unanswered calls, or DND Forward to forward calls when the phone is in DND mode. Press OK.
3. Select Status and press OK.
4. Use the up/down navigation arrows to enable call forwarding (on) or disable (off) call forwarding and press OK.
5. Select Forward Number to enter the phone number where you want calls forwarded and press OK.
6. Select Forward Call Type. ICM enables call forwarding only for calls from an internal extension. Outside enables call forwarding for calls from an outside line or networked TOS 3000 system. Both forwards all calls.
7. When enabling No Answer Forwarding, you must set the No Answer Time. If the call is not answered after the no answer timer expires, the call is then forwarded to the no answer forwarding destination. (Default value is 15 seconds.)

Call Log:

1. Press the LCD Menu soft key.
2. Select Call Log and press OK to open the call log menu.
3. Scroll to select Dialed Calls, Missed Calls, or Received Calls and press OK.
4. Use the navigation keys to scroll through your calls.
5. You may choose to Dial, Delete/Delete All Number(s) or press Cancel to exit the menu.

pressing the Hold key.

2. Use the up/down arrow navigation keys to select an unused channel to dial.
3. Use the dial pad to dial an extension or outside telephone number and press OK.
5. When the called party answers you can speak to the called party before transferring.
6. Press the Transfer key to complete the transfer.

Voice Mail:

1. Press the Message key or dial the voice mail access code _____ to access your voice mailbox.
2. When prompted, enter your voice mailbox pass code.



Volume Adjustment While on a Call:

1. During a conversation (handset, headset, or hands-free), you can adjust the receive audio through the handset, headset or speaker using the volume control key.
2. Press the volume control + key to raise the volume or volume control – key to lower the volume. The audio level will display on the LCD. Please note that the lowest level turns the receive audio OFF.











Advanced Call Features

Call Blocking Based on Caller ID:

1. Press the LCD Menu soft key and use the navigation keys to select Call Blocking and press OK.
2. To enable choose Status and use the navigation keys to toggle to ON. Press OK to save.
3. To edit one of the ten entries, select Blocking List, then a number (0-9). Press OK, then Edit to enter a number. When finished press OK to save. Calls from this number will no longer ring your extension and instead

No	Part Name	Description
	 Phonebook Key	Press the Phonebook key to access the phonebook to call or edit contacts.
19	 Volume Control	Use to adjust the ringer, handset, headset, or speakerphone volume level or turn off the audio. Adjust ringer volume when the station is idle. Adjust the handset, headset, or speaker volume (when active).
20	 Dial Pad	Telephone dial pad. (1-9, 0, *, and #).
21	Microphone	Microphone input under the IP2061 lower front edge.

LED Overview

LED	Color	Status	Description
 Message	 Red	Off	Idle or no new message.
		Slow Blink	New voice message indication.
		Rapid Blink	There is an incoming call.
		Rapid Blink (Constant)	IP2061 cannot register to TOS3000 system.
 Speaker key	 Green	Off	The hands-free speaker is not in use.
		Steady	In on-hook dialing mode or hands-free talking mode.
 Mute key	 Red	Off	The microphone is on for handset, headset, or hands-free mode.
		Steady	The microphone is off (muted) for handset, headset, or hands-free mode.
 Headset key	 Green	Off	Headset mode is disabled.
		Steady	Headset mode is enabled.
 Lines keys 1-4	 Green	Off	The line is idle
		Steady	The line is active (dialing or on a call).
		Slow Blink	A call is on hold.
		Rapid Blink	Incoming call.

Do Not Disturb (DND):

1. Use this feature to prevent calls from ringing at your extension. When enabled, calls will follow the DND forward setting (default voice mail).
2. Press the LCD Menu DND soft key. Notice the DND icon at the top right corner of the display.

Hold:

1. While on an active call press the Hold key.
2. To pick-up the held call, press the Hold key or if the call is held on a Line key, you can also press the Line key to pick-up the call. You can also use the Navigation key to scroll through the list of calls on the display.

Last Number Redial:

1. Press the Redial key.
2. The IP2061 phone will display the last 30 dialed numbers.
3. Use the navigation keys to select a number and press the Dial soft key to redial.

Mute:

1. During a conversation (handset, headset, or hands-free), you can mute the microphone by pressing the Mute key. The Mute key will light red when mute is active.

Transfer (Blind Transfer):

1. While on an active call press the Transfer key.
2. The system will prompt you to enter the number where you would like to transfer the call.
3. Use the dial pad to dial an extension or outside telephone number and press OK.
4. Hang up to complete the transfer.

Transfer (Supervised Transfer):

1. While on an active call place the first call on hold by

Making a Call:

1. Lift the handset or press the Speaker key. Note. If using a headset make sure the Headset key is active.
2. Use the dial pad to dial an extension number or outside phone number. You may also choose to dial a phone number by entering the IP address of the telephone. E.g., to dial 192.168.1.11, enter the following: 192*168*1*11.
3. Press OK or the Dial soft key to dial the number, or wait for the dial timeout (default 5 seconds). The IP2061 will select the first available line to dial the number.
4. When your party answers, begin speaking.
5. Hang up to end the call.

Receiving a Call:

1. Lift the handset or press the Speaker key. Note. If using a headset make sure the Headset key is active.
2. Begin speaking.
3. Hang up or press Speaker to end the call.

Conference:

1. While on an active call, you can invite another party to join using the 3-party conference call feature.
2. Place the first call on hold by pressing the Hold key.
3. Use the up/down arrow navigation keys to select an unused channel to dial.
4. Use the dial pad to dial an extension or outside telephone number and press OK.
5. When the outside party answers press the Conference key to start the three-way conference. The LCD will display CONF to show that the two calls are joined in the conference.
6. Please note the conference call will end for all parties when the TOS 3000 extension hangs up.

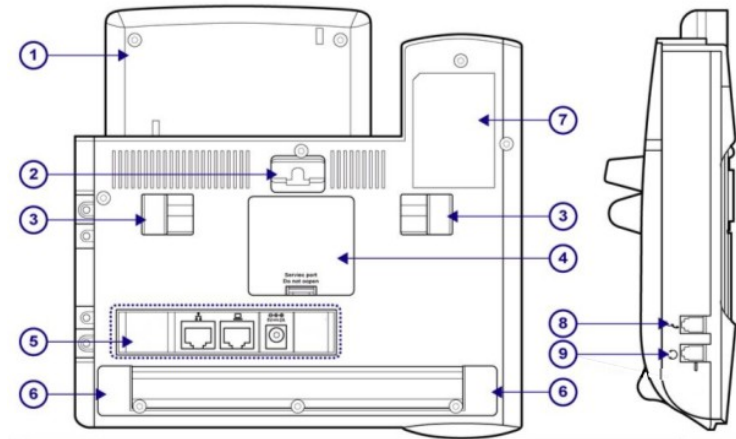

IP2061 Rear-View

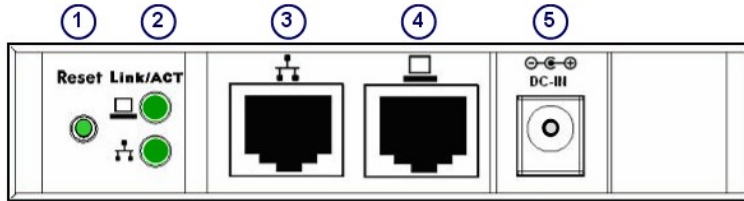

No	Part Name	Description
1	LCD Housing	Houses the LCD display.
2	Wall-Mount Slot	For wall-mounting the telephone.
3	Pedestal Stand Support Hinges	Houses the three-position adjustable desktop pedestal support. Remove the pedestal support before wall-mounting.
4	Service Door	For service only. (Do not remove).
5	Input/Output Connectors	Ethernet and power connector ports for the IP2061. (Refer to the next page for details).
6	Pedestal Base Hinges	Houses the three-position adjustable desktop base. When folded flat, the pedestal base is also used for wall-mounting the telephone.
7	Product label	Displays telephone information: Model, Serial Number, MAC Address, and Input Power specifications.
8	Handset Jack	RJ-9 Handset cord jack.
9	Headset Jack	RJ-9 Headset jack.

IP2061 I/O Ports



No	Part Name	Description
1	Reset Button	Manual reset to return the IP2061 to the factory default settings.
2	Link/Activity LEDs	WAN / LAN link activity indicators.
3	 RJ-45 Ethernet Port	10/100 Mbps Ethernet port for connecting the IP2061 to an IP network. This port also supports Power-over-Ethernet (PoE) (IEEE802.3af standard).
4	 RJ-45 Ethernet Port	10/100 Mbps Ethernet port for connecting to a PC.
5	 Power Input	The IP2061 can be powered by the 5V/2A power adapter (included with the IP2061). This device supports a power auto-switch function and can switch from AC power to PoE (if available).

Desktop Stand Adjustment

The illustration below describes how to configure the IP2061 desktop stand.



Steps D, E, and F demonstrate the 30°, 45°, and 60° pedestal positions.

Basic Call Features

Three Ways to Use the Phone:

1. **Handset** – Lift the handset from the cradle to answer.
2. **Hands-Free / Speakerphone** – You can enter hands-free mode by pressing the Speaker key. To end a call, press the Speaker key to hang-up.
3. **Headset** – The Headset key is used to enable/disable headset mode, when enabled, it will switch the phone from hands-free to headset mode when the Speaker key is pressed. **When in headset mode use the Speaker key to answer and end a call.**