

MITEL

5000 Communications Platform (CP)

8560/8660 Phone



User Guide





Mitel 8560/8660 Phone Quick Reference Guide

This guide provides information for frequently used features. For more information about these and other features, refer to the user guide. For voice mail information, refer to the voice mail user guide for your system.

Feature Buttons

Most of the following feature codes work when your phone is idle. However, if you are on an active call or if the phone is off-hook, you may need to press  (Special) to activate the feature before you enter the feature code.

If you make a mistake when entering numbers or characters, you can press the **MUTE** button to move the cursor to the left and delete the characters entered, or you can press * to cancel the feature.

Button	Action
	Activates features while on active calls.
	Provides volume control. Scrolls through feature options.
	Activates Handsfree Mode. Turns speaker on and off.
	Places the current call on hold.
CALL	Selects an outside line or answers a call.
IC	Answers an intercom (internal) call.
MUTE	Mutes the microphone. Left/backspace when entering dialpad characters.
DND	Turns DND mode on or off.
PAGE	Selects a page zone to place a page.
STN SPDL	Views or accesses Station Speed-Dial numbers.
SYS SPDL	Views or accesses System Speed-Dial numbers.
CNF	Places a conference call.
REDIAL	Redials a telephone number.
TRANSFER	Transfers the current call.
MSG	Connects to silent and voice messages. Toggles between Alpha Mode and Numeric Mode.
FWD	Forwards the call to the specified number. Right/forward when entering dialpad characters.
ANSWER	Answers calls.
OUTGOING	Selects an outgoing line for external calls.

Commonly Used Feature Codes

Contact your system administrator for more information about system features.

Feature	Code
ACD Agent – Log In/Out	328
Automatic IC Call Access – On/Off	361
Automatic Trunk Call Access – On/Off	360
Background Music – On/Off	313
Call Forward – All Calls	355
Call Logging	333
Conference	5
Default Station	394
Directory	307
Display Time And Date	300
Do-Not-Disturb – On/Off	372
Dynamic Extension Express – On/Off	364
Dynamic Extension Express Handoff	388
Handsfree – On/Off	319
Headset – On/Off	317
Hold – Individual	336
Hold – System	335
Hot Desk On/Off	348
Hunt Group – Remove/Replace	324
Message – Cancel Left Message	366
Message – Delete Message	368
Message – Leave Message	367
Message – View Messages Menu	365
Microphone Mute – On/Off	314
Page Receive – On/Off	325
Program Buttons	397
Program Station Passcode	392
Programmable Buttons – Default	395
Queue (Callback) Request	6
Record-A-Call	385
Reverse Transfer (Call Pick-Up)	4
Ring Tone Selection	398
Station Speed Dial	382
Station Speed Dial – Programming	383
Switch Keymap	399
System Forward – On/Off	354
System Speed Dial	381
View Button Assignments	396

Answering Calls

Lift the handset, or press  (Speaker) to answer a call while using a headset or to answer a call in Handsfree Mode.

Placing Emergency Calls

Dial the emergency number (911 U.S. or 999/112 Europe). The system immediately places the emergency call as soon as you dial the number, even if you do not select an outside line.

Placing Internal (Intercom) Calls

With or without the handset lifted, dial the extension number. If you enter incorrect digits, you can press the **MUTE** button to move the cursor backward, deleting the last digits entered. If you are using Handsfree Mode, listen for the double tone, and then begin to speak.

Placing External Calls

Press the **OUTGOING** button or enter the Outgoing Call access code (**8** is the default code), and then dial the number.

Redialing External Numbers

With or without the handset lifted, press the **REDIAL** button. The system automatically selects a line and dials the number.

Transferring Calls to Other Extensions

1. While on the call, press the **TRANSFER** button, and then enter the extension number.
2. Do one of the following:
 - Wait for an answer, announce the call, and then hang up. If the extension is unavailable, press the flashing **IC** or **Call** button to return to the caller.
 - Hang up to transfer the call and disconnect the call from your phone.

Forwarding Calls

1. Press the **FWD** button, and then enter the feature code, if applicable. ENTER FORWARD DEST appears.
2. Enter the extension number, or press the **OUTGOING** button or enter the Outgoing Call access code (**8** is the default code), and then dial the telephone number.



Placing Ad Hoc Conference Calls

1. While on the first call, press the **CNF** button to place the call on hold. CALL NEXT PARTY TO CNF appears.
2. Place a call to the next conference party. For external calls, press the **OUTGOING** button or enter the Outgoing Call access code (**8** is the default code), and then dial the number.
3. After the party answers, announce the conference, and then press the **CNF** button to place the call on hold. If necessary, repeat this step to add the remaining conference party.
4. Press the **CNF** button again or the **CONNECT TO CNF** menu button to start the conference. CNF IN PROGRESS appears.

Viewing and Responding to Messages

1. With the handset on-hook, press the **MSG** button. Messages are displayed as first in/first out. If there is more than one message, you can repeatedly press the **MSG** button or the **NEXT** and **PREVIOUS** menu buttons to scroll through the messages.
2. When the desired message is displayed, press **#** or lift the handset for privacy, and then press **#** or the **Reply** menu button to respond. (If your handset is off-hook and you press the **MSG** button, you automatically place a call to the party or message center that left the message.)

Using Do-Not-Disturb

1. Press the **DND** button, and then do one of the following:
 - Press  (Up) or  (Down) to scroll through the messages.
 - Enter the two-digit number for the DND message.
2. If applicable, enter the additional text for the DND description.
3. Press  (Speaker) or the **ACCEPT** menu button, or lift and replace the handset.

Placing a Page Announcement

1. Press the **PAGE** button.
2. Enter the page-zone number (**0** to **9**).
3. After the tone, make your announcement, and then hang up.

Notice

This guide is released by Mitel Networks Corporation and provides information necessary to use 8560/8660 Phones. The guide contents, which reflect current Mitel standards, are subject to revision or change without notice.

Some features or applications mentioned may require a future release and are not available in the initial release. Future product features and applications are subject to availability and cost. Some features or applications may require additional hardware, software, or system administrator assistance.

For sales, service, or technical support, contact your local authorized provider:

Enter provider information above.

If you do not know the contact information for your local provider, use the “Strategic Partners & Resellers – Mitel Partner Locator” link at the top of the [Mitel home page](http://www.mitel.com) (www.mitel.com) to find a location near you.

If you have any questions or comments regarding this user guide or other technical documentation, contact the Technical Publications Department (USA) at:

tech_pubs@mitel.com

Mitel® is a registered trademark of Mitel Networks Corporation.

All other trademarks mentioned in this document are the property of their respective owners, including Mitel Networks Corporation. All rights reserved.

©2003–2011 Mitel Networks Corporation

Personal use of this material is permitted. However, permission to reprint/republish this material for advertising or promotional purposes or for creating new collective works for resale or redistribution to servers or lists, or to reuse any copyrighted component of this work in other works must be obtained from Mitel.

Important Safety Instructions and Precautions

Remember the following safety guidelines when using the phone.





Programming Emergency Numbers

Make sure to do the following when programming emergency numbers and/or making test calls to emergency numbers:

- Remain on the line and briefly explain to the dispatcher the reason for the call.
- Perform tests during off-peak hours such as early morning or late evenings.

Safety Notices

The following notices may appear on the product or in the technical documentation.

Notice	Description
 CAUTION	Caution indicates a potentially hazardous situation which, if not avoided, may result in minor or moderate injury and/or damage to the equipment or property.
 WARNING	Warning indicates a potentially hazardous situation which, if not avoided, could result in death or serious injury.
 DANGER	Danger indicates an imminently hazardous situation which, if not avoided, will result in death or serious injury.
	The exclamation point within an equilateral triangle indicates that important operating and maintenance (servicing) instructions are included in the literature accompanying the product.

Maintenance and Repair

There are no user serviceable parts inside the phones. For repairs, return the phone to an authorized Mitel provider.

NOTE

Changes or modifications not expressly approved by Mitel may void the user's right to operate the equipment.

Product Disposal Instructions



This symbol indicates that the product is classified as electrical or electronic equipment and should not be disposed of with other commercial or household waste at the end of its working life. For appropriate disposal and recycling instructions, contact your local Mitel provider.

The Waste of Electrical and Electronic Equipment (WEEE) Directive (2002/96/EC) was established by the European Union to minimize negative impact on the environment, control hazardous substances, and curtail landfill expansion by using the best available recovery and recycling techniques.

Power Requirements

CAUTION

Phone Damage Hazard. If you are using an IP phone, make sure it is connected to the proper power supply before powering on. Contact your system administrator for more information.

The IP phone requires *any* one of the following power supplies:

- Inter-Tel Power Supply Unit, part number 806.1114 or 806.1117 (Europe), or Mitel Universal Power Supply Unit, part number 828.1766
- Red Hawk Single Port PowerSense™, Part Number 901.0407
- An industry-standard IEEE 802.3af Power over Ethernet (PoE) power supply unit

If your phone uses a centralized PoE power supply unit, do **not** use the 48-volt DC Ethernet power adaptor. If necessary, contact your system administrator for assistance before connecting your phone to the centralized power source.

Make sure the phone is plugged into an uninterruptible power supply (UPS). If your phone is plugged into the UPS and the power fails, it should remain powered on for about 10 minutes. If the phone is not plugged into a UPS and the power fails, the current call is dropped and you will not be able to use the phone until the power is restored.

Software and Firmware Updates

If you are using an IP phone, it IP may require occasional software updates when new versions are available. The phone is configured to download the updates automatically. Contact your system administrator for more information. During the download process several messages are shown on the display that indicate the status of the download. The final display message, FIRMWARE DOWNLOAD SUCCESS or BOOT DOWNLOAD SUCCESS, indicates that the software or firmware update was downloaded successfully.

Immediately following the download your phone will re-synchronize with the telephone system by performing a reset. When the display returns to your extension number, your user name, the time of day, and the date, the reset is complete and you can use your phone again. During a reset, your phone (and all connected devices) lose connectivity with the network for approximately 10 -20 seconds.

CAUTION

Phone Damage Hazard. Do not use your IP phone or disconnect it from the power supply while it is updating software.

Software Compatibility

Depending upon which software version your telephone system is using, some of the features included in this guide may not be available for your phone. Check with your system administrator to see which software version your telephone system currently uses and if there are any feature restrictions for your system.

Phone Usage

This equipment is not for connection to the telephone network or public coin phone service. It is only for use when connected to Mitel systems.

WARNING

When using your phone equipment, basic safety precautions should always be followed to reduce the risk of fire, electric shock and injury to persons, including the following:

- Do not use this product near water, for example, near a bath tub, wash bowl, kitchen sink or laundry tub, in a wet basement, or near a swimming pool.
- Avoid using a phone (other than a cordless type) during an electrical storm. There may be a remote risk of electric shock from lightning.
- Do not use the phone to report a gas leak in the vicinity of a leak.
- Do not connect directly to the Public Switched Telephone Network (PSTN). Any connection of this phone to an off premise application, an out of plant application, any other exposed plant application, or to any equipment other than the intended application may result in a safety hazard, and/or defective operation, and/or equipment damage. "Exposed plant" means where any portion of the circuit is subject to accidental contact with electric lighting or power conductors operating at a voltage exceeding 300 volts between conductors or is subject to lightning strikes.
- The socket outlet, if used, shall be located near the equipment and shall be easily located by the user.
- Use only Mitel approved power adaptors. See "Power Requirements" on [page vii](#).
- The handset supplied with the phone is not certified for use with any other phone. Use of the handset with any other phone may have the potential to cause hearing loss in the event of a lightning strike on the outside plant wiring.

Notice to Canadian Customers

The Class B digital apparatus complies with Canadian ICES-003.

Notice to U.S. Customers

This equipment has been tested and found to comply with the limits for a Class B digital device, pursuant to Part 15 of the FCC Rules. These limits are designed to provide reasonable protection against harmful interference in a residential installation. This equipment generates, uses, and can radiate radio frequency energy and, if not installed and used in accordance with the instructions, may cause harmful interference to radio communications. However, there is no guarantee that interference will not occur in a particular installation. If this equipment does cause harmful interference to radio or television reception, which can be determined by turning the equipment off and on, the user is encouraged to try to correct the interference by one or more of the following measures:

- Reorient or relocate the receiving antenna.
- Increase the separation between the equipment and receiver.
- Connect the equipment into an outlet on a circuit different from that to which the receiver is connected.
- Consult the dealer or an experienced radio/TV technician for help.

Notice to European Customers



We, Mitel Networks LTD.
Of, Mitel Castlegate Business Park
Portskewett
Caldicot
NP26 5YR
UK

Declare that for the hereinafter mentioned product the presumption of conformity with the applicable essential requirements of DIRECTIVE 1999/5/EC OF THE EUROPEAN PARLIAMENT (RTTE DIRECTIVE) AND OF THE COUNCIL is given.

Mitel Phones: 8560/8660

Any unauthorized modification of the product voids this Declaration.

For a copy of the original signed Declaration of Conformity (in full conformance with EN45014), please contact the Regulatory Approvals Manager at the above address.

Contents

Getting Started 1

Welcome	1
About Your Phone	2
Feature Descriptions	3
Handset	3
Display	3
Message Indicator Lamp	4
Menu Buttons	4
Programmable Buttons	4
Dialpad Buttons	4
Speaker	4
Feature Buttons	5
Phone Connectors	6
8660 IP Phone Exceptions	7
Phone Signals	7
Comfort and Safety Tips	7
Headset Instructions	8

Personalizing Your Phone 9

Adjusting the Viewing Angle	9
Changing Volume Levels	9
Changing the Ring Tone	9
Adjusting the Display Contrast	10
Listening to Background Music	10
Changing the Language	10
Using the Dialpad Buttons to Enter Characters	11
Using Programmable Buttons	14
Additional Programmable Buttons	14
Default Access Codes	15
Outside Line Access Codes	15
Extension Numbers	15
Default Feature Codes	16
Viewing Button Assignments	18
Resetting Programmable Buttons	18
Resetting the Phone to the Default Settings	19
Switching Keymaps	19
Activating Door Relay	19

Answering and Placing Calls **21**

Answering Calls **21**

Answering Waiting Calls **21**

Using Automatic Call Access **22**

Redirecting Calls 22

Using Automatic Trunk Answer **22**

Placing Calls **23**

Placing Emergency Calls 23

Placing Internal Calls 23

Requesting a Callback (Queuing the Phone) 23

Using Camp-on 23

Off-Hook Voice Announce 24

Placing External Calls 24

Redialing a Number 25

Using Speed Dial **26**

Using System Speed Dial 26

Using Station Speed Dial 26

Storing Station Speed-Dial Numbers 26

Dialing Station Speed-Dial Numbers 26

Deleting Station Speed-Dial Entries 27

Assigning Speed-Dial Numbers to Programmable Buttons 27

Using the Directory **28**

Using Account Codes **29**

Call Features **31**

Using Handsfree Mode **31**

Using Ring Intercom Always **31**

Using Mute **31**

Placing Calls On Hold **32**

Entering a Hookflash **32**

Transferring Calls **33**

Transferring Calls to Other Extensions 33

Transferring Calls to External Numbers 33

Using Reverse Transfer 33

Viewing Your System Information **34**

Viewing Caller ID Information **34**

Forwarding Calls **35**

Manual Call Forwarding 35

System Forwarding 35

Using Dynamic Extension Express	36
Using the Handoff - Push/Pull Feature.	37
Receiving Message Waiting Indications.	38
Placing Ad Hoc Conference Calls	39
Adding a Conference Party	39
Transferring a Conference	39
Dropping Out of a Conference	39
Ending a Conference and Placing all Parties on Hold	40
Using Meet-Me Conferencing	41
Conference Assistant.	41
Access Codes	41
Setting Up a Meet-Me Conference.	41
Joining a Meet-Me Conference	42
Dropping Out of a Meet-Me Conference	42
Putting a Meet-Me Conference on Hold.	42
Transferring a Meet-Me Conference	42
Using Record-A-Call	43
Using Group Listen	44
Using Call Logging	44
Using Secondary Extension Buttons.	45
Using Hot Desking.	46
Using Configuration Assistant	47
Changing Your Station Passcode	47
Accessing Configuration Assistant.	48
Changing the Dynamic Extension Express Settings	48
Changing the DND Settings	49
Changing the Manual Call Forwarding Settings.	49
Managing Meet-Me Conferencing Access Codes	50
Using Remote Programming	51
Changing the Dynamic Extension Express Settings	51
Changing the DND Settings	52
Changing the Manual Call Forwarding Settings.	52
Changing Your Station Passcode	53

Messages **55**

Leaving Messages at Other Extensions 55

Viewing and Responding to Messages 56

Canceling Messages Left at Other Extensions 56

Deleting Waiting Inter-Station Messages 56

Using Do-Not-Disturb 57

Using Reminder Messages 58

Paging Other System Users 59

 Placing a Page Announcement 59

 Enabling or Disabling the Page Feature 59

Hunt Groups **61**

Logging in to ACD Hunt Groups 61

Logging out of ACD Hunt Groups 62

Stopping the ACD Hunt Group Wrap-up Timer 62

Other Hunt Group Features 63

 Requesting Agent Help 63

 Diverting Hunt Group Calls 63

Hunt Group Supervisor Features 64

 Accepting or Rejecting Agent Help Calls 64

 Monitoring Calls 64

 Stealing Hunt Group Calls 64

 Using Barge-in 65

Troubleshooting **67**

Contact Information 67

Error Messages 67

Troubleshooting Tips 68

Index **71**

Getting Started

Welcome

The instructions in this guide are for using your 8560 Telephone or 8660 IP Phone on the Mitel 5000 Communications Platform (CP). The *Quick Reference Guide* located at the beginning of this user guide is an overview of frequently used features.

Your phone should be powered on and ready to use. If the display is blank, or if the display name, extension number, or time or date are incorrect, contact your system administrator for assistance.

Because a variety of voice mail products work with the Mitel 5000 CP, this guide does not include voice mail instructions. For voice mail instructions, refer to the voice mail user guide for your system. For example, refer to the *Enterprise Messaging, Unified Voice Messaging, and Embedded Voice Mail Card User Guide*, part number 835.3205, or the *Mitel NuPoint Unified Messaging User Guide* (on the [Mitel Web site](http://edocs.mitel.com) <http://edocs.mitel.com>). Contact your system administrator for more information about your voice mail system.

NOTE

Because many phone features can be programmed to perform various tasks, some features may work differently than the descriptions in this guide. Contact your system administrator for more information.

About Your Phone

Your phone is equipped with a six-line display, a hearing aid-compatible handset, a Message Indicator lamp, an internal speaker and microphone, and three types of buttons.

See “Feature Descriptions” on [page 3](#) for more information about the phone features.



- | | |
|----------------------------|--------------------------|
| 1 – Handset | 5 – Programmable buttons |
| 2 – Display | 6 – Dialpad buttons |
| 3 – Message Indicator lamp | 7 – Feature buttons |
| 4 – Menu buttons | 8 – Speaker |

Feature Descriptions

The following sections describe default configurations. Your phone may be programmed differently. Contact your system administrator for more information. See “About Your Phone” on [page 2](#) for phone feature locations.

Handset

The handset provided with this equipment is hearing aid compatible (HAC). If you are using a headset or if you are in Handsfree Mode, you do not need to use the handset.

Display

The phone has a six-line display. When the phone is idle, the top two lines show user and system information, including:

- Extension number
- User name
- Time and date
- Call information (during a call)
- Message indication (after messages are received)

Following are the feature display abbreviations:

Abbreviation	Word or Phrase
ACCT CODE	Account Code
CNF	Conference
DEST	Destination
DIR	Directory
DND	Do-Not-Disturb
EXT	Extension
LOGS	Call Logging
MSG	Message
RCL	Recall
SPKR	Speaker
SPKRPHN	Speakerphone
STN SPD	Station Speed Dial
SYS SPD	System Speed Dial
TFR	Transfer
TG	Trunk Group (a group of outside lines)
TRNK	Trunk (an outside line)
MISSED (number)	Missed Calls

Message Indicator Lamp

The Message Indicator lamp flashes or stays lit to indicate call, message, and feature activity. See “Leaving Messages at Other Extensions” on [page 55](#).

NOTE

By default, the Message Indicator lamp is lit when you receive new messages. However, this lamp can be programmed for other functions. Contact your system administrator for more information.

Message Indicator lamp signals are described in the following table.

Message Indicator Lamp Signal	Description
Rapidly flashing	You have an incoming call.
Slowly flashing	You have a waiting message or callback message.
On	You are on a call or using a feature.
Off	Your phone is idle.

Menu Buttons

The phone has eight dynamic menu buttons at the top of the display that change depending on the feature and menu currently shown. You can use the menu buttons to view and select feature options.

Programmable Buttons

Most of the buttons on your phone are preprogrammed by the system administrator. However, you can program some of the phone buttons for quick access to features or speed-dial entries. See “Using Programmable Buttons” on [page 14](#) for instructions.

Dialpad Buttons





Use the dialpad buttons to dial phone numbers, enter feature codes, and to enter characters when using features that require text input.

Speaker

The speaker provides audio for handsfree calls and background music. See “Using Handsfree Mode” on [page 31](#) for information about handsfree calls. See “Listening to Background Music” on [page 10](#) for more information about background music.

Feature Buttons

Feature buttons provide quick access to commonly used features. See the following table for descriptions.

Button	Action
 (Special)	Activates features while on active calls. Depending on how your system is configured, you may need to press this button before you dial a feature code.
 (Up)  (Down)	Provides volume control for the ringer, handset, and speaker. Scrolls through feature options.
 (Speaker)	Activates Handsfree Mode (speakerphone). See “Using Handsfree Mode” on page 31 . Activates features.
 (Hold)	Places the current call on hold.
CALL	Selects an outside line or answers a call.
IC	Answers an intercom (internal) call.
MUTE	Mutes the microphone. Left/backspace when entering dialpad characters. See “Using the Dialpad Buttons to Enter Characters” on page 11 .
DND	Turns DND mode on or off. See “Using Do-Not-Disturb” on page 57 .
PAGE	Selects a page zone to place a page.
STN SPDL	Views or accesses Station Speed-Dial numbers.
SYS SPDL	Views or accesses System Speed-Dial numbers.
REDIAL	Redials a telephone number or saves the last number dialed.
CNF	Places a conference call.
TRANSFER	Transfers the current call.
MSG	Connects to inter-station and voice messages. Toggles between Alpha Mode and Numeric Mode when entering dialpad characters.
FWD	Forwards the call to the specified number. Right/forward when entering dialpad characters. See “Using the Dialpad Buttons to Enter Characters” on page 11 .
ANSWER	Answers calls.
OUTGOING	Selects an outgoing line for external calls.

Phone Connectors

The phone connectors include:

- **Headset port:** Connects to a headset.
- **Handset port:** Connects to a handset.
- **24 V Power port:** Connects to a 24VDC external power supply (8660 IP Phones only).
- **Personal Computer (PC) Ports 1-3:** Connect to PCs or any other 10/100 Ethernet devices (8660 IP Phones only).
- **LAN/Power port:** Connects to a network hub or a switch (8660 IP Phones only).

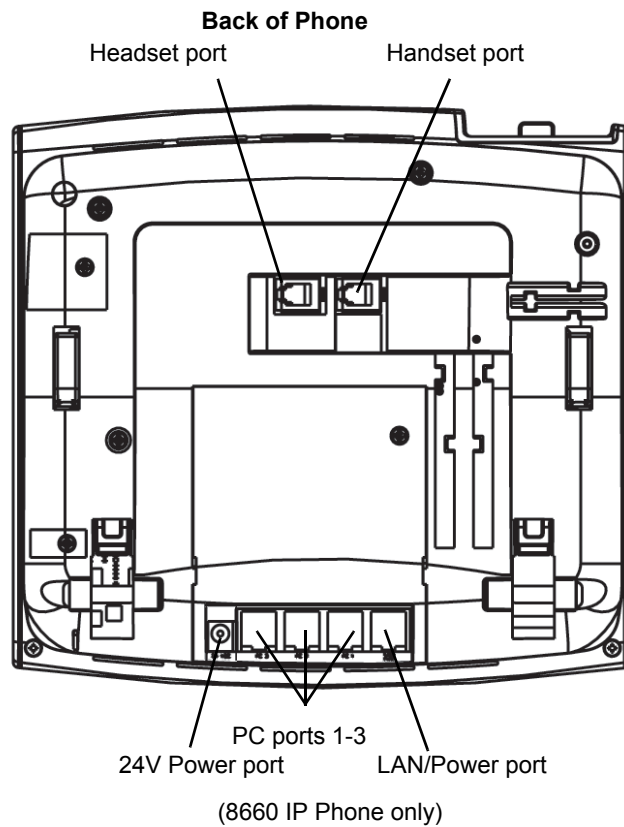

8660 IP Phone Exceptions

The 8660 IP phone looks and functions almost identically to the 8560 Telephone, with the following exceptions:

- The 8660 IP Phone has additional ports on the back that are used for Internet and power connections (see [page 6](#)).
- The 8660 IP Phone does not support the Programmable Key Module (PKM) or Direct Station Selection/Busy Lamp Field (DSS/BLF) unit (see [page 18](#)).
- The 8660 IP Phone does not support the Off-Hook Voice Announce Feature (see [page 24](#)).

WARNING

Contact your system administrator and your local Mitel provider for important information about dialing emergency services before using your 8660 IP phone.

Phone Signals

The phone has several audio and visual signals to indicate feature activity. The following are a few helpful tips:

- Any buttons that are lit or blinking indicate call or feature activity.
- All phone button lamps illuminate at the same time for a few seconds when the phone is reset or powered on.
- The following actions may cause an error tone:
 - Pressing an invalid button combination.
 - Selecting a restricted feature.
 - Dialing a restricted or invalid number.
 - Dialing too slowly between digits.
 - Waiting too long before performing the next step.

To correct an error tone, hang up and try again.

- Many features “time-out” if you wait too long before performing the next step. If this happens, you must start over.
- “Off-hook” means the handset is in use. “On-hook” means the handset is idle.

Comfort and Safety Tips

Observe the following comfort and safety tips when using the phone:

- **Do not cradle the handset:** Prolonged use of the handset can lead to neck, shoulder, or back discomfort, especially if you cradle the handset between your neck and shoulder. If you frequently use the phone, you might find a headset more comfortable. See “Headset Instructions” on [page 8](#).
- **Adjust the viewing angle:** The built-in stand tilts to give you a better view of the buttons. See “Adjusting the Viewing Angle” on [page 9](#).
- **Protect your hearing:** Because prolonged exposure to loud sounds can contribute to hearing loss, keep the volume at a moderate level. You can adjust the volume levels of the handset receiver or headset. See “Changing Volume Levels” on [page 9](#).

Headset Instructions

When using a headset, press  (Speaker) to connect to or disconnect from calls.

If you have both a headset and a handset connected to your phone and you are using the headset, you can quickly transfer audio to the handset by lifting the handset from the cradle. Press  to transfer the call back to the headset before replacing the handset in the cradle.

NOTES

The headset must be HAC.

If your headset has a power-saver mode, make sure the system administrator has enabled the “Headset Connect Tone” feature. If this is not enabled, you may miss the first few seconds of an incoming call.

To connect and activate the headset:

1. Insert the headset jack into the Headset port located on the back of the phone. See “Phone Connectors” on [page 6](#).
2. Dial **317** to turn the headset on. HEADSET MODE ON appears.

To turn off Headset Mode and activate the handset and speakerphone:

Dial **317**. HEADSET MODE OFF appears.

Personalizing Your Phone

This chapter describes features you can use to personalize your phone.

Adjusting the Viewing Angle

You can tilt the phone stand for a better view of the buttons and display.

To adjust the viewing angle:

1. Position the bottom of the phone base on a flat surface.
2. Tilt the phone to the desired angle.
3. Place the “feet” of the support mechanism in the holes on the base to secure the position of the phone.



Changing Volume Levels

You can change the following volume levels:

- Ringer (alerting tone)
- Handset
- Headset
- Background music
- External speaker

You must be using the feature to change the volume level. For example, if you want to change the handset volume level, you must be using the handset. However, you can adjust the ringer (alerting tone) volume level when the phone is idle.



To change a volume level:

1. While using the feature, press  (Up) to increase the volume, or press  (Down) to decrease the volume. The volume level is automatically saved.
2. Press the center of the button to save the setting.

Changing the Ring Tone

You can select one of nine different ring tones.



To change the ring tone:

1. With the handset on-hook, dial **398**.
2. Do one of the following to listen to (or turn off) ring tones:
 - Press **0** or the RINGER OFF menu button to turn the ringer off.
 - Press  (Up) or  (Down) or **1 to 9** to listen to ring tones.
 - Press the PREVIOUS or NEXT menu buttons to listen to and select a ring tone.
3. Press  (Speaker), **#**, the **ACCEPT** menu button, or lift and replace the handset to select the ring tone.

Adjusting the Display Contrast

You can adjust the display Contrast setting.

To adjust the Contrast setting:

1. While the handset is on-hook, dial **303**.
2. Do one of the following:
 - Press  (Up) or  (Down) to adjust the contrast.
 - Press a number on the dialpad (1 = lightest, 8 = darkest) that corresponds to your desired contrast level.
3. To save the setting, press **#** or  (Speaker).

Listening to Background Music

If your system is equipped with a music source, you can listen to Background Music or system audio (for example, organizational conference calls) through the external speaker.

To turn background music on or off:

Dial **313** to turn background music on. BACKGROUND MUSIC ON appears. Dial **313** to turn background music off.

Changing the Language

Your system administrator can select two of the following languages as the primary and secondary languages to display text:¹

- American English
- British English
- Canadian French
- Mexican Spanish
- Japanese

The language choices appearing on your display are controlled by system programming. You can change the language by selecting the secondary language. Contact your system administrator for more information.

To change the language:

Dial **301** to select either the primary or secondary language. The display shows text in the selected language.

1. This feature may or may not be enabled for your system.

Using the Dialpad Buttons to Enter Characters

You can use the dialpad buttons to enter text or numbers for features such as Do-Not-Disturb (see [page 69](#)) and Station Speed Dial (see [page 38](#)).

The following are guidelines when entering dialpad characters:

- Press (Message) to switch from Alpha Mode to Numeric Mode. The **MSG** button stays lit in Alpha Mode. It is off in Numeric Mode.
- Press the **MUTE** button to move the cursor to the left and delete characters.
- Press the **FWD** button to move the cursor to the right.
- In Numeric Mode, press **#** for a hyphen (-).
- In Numeric Mode, press ***** for a colon (:).
- Press  (Speaker), or lift and replace the handset to save entries.

To use the dialpad to enter characters:

Press the dialpad buttons as shown in the following table.

Dialpad Characters — American English and British English

Button	Number of Times Dialpad Button is Pressed														
	1	2	3	4	5	6	7	8	9	10	11	12	13	14	15
1	:	-	/	,	.	;	()	&	+	*	!	?	#	1	
2	A	B	C	2	a	b	c								
3	D	E	F	3	d	e	f								
4	G	H	I	4	g	h	i								
5	J	K	L	5	j	k	l								
6	M	N	O	6	m	n	o								
7	P	Q	R	S	7	p	q	r	s						
8	T	U	V	8	t	u	v								
9	W	X	Y	Z	9	w	x	y	z						
0	0														

For example, to enter **May 31**, you could use the following sequence:

1. In Alpha Mode (**MSG** button is lit), press **6** once to enter an “M.”
2. Press **2** once to enter an “A.”
3. Press **9** three times to enter a “Y.”
4. Press **FWD** to enter a space.
5. Press **MSG** to switch to Numeric Mode.
6. Press **3**.
7. Press **1**.
8. Press , **#**, or lift the handset to save the entry.

Personalizing Your Phone

The following tables show the dialpad characters for the Canadian French and Mexican Spanish languages.

Dialpad Characters — Canadian French

Button	Number of Times Dialpad Button is Pressed														
	1	2	3	4	5	6	7	8	9	10	11	12	13	14	15
1	:	-	/	,	.	;	()	&	+	*	!	?	#	1	
2	A	B	C	2	A	b	c	À	Â	Æ	Ç	à	â	æ	ç
3	D	E	F	3	D	e	f	È	É	Ê	Ë	è	é	ê	ë
4	G	H	I	4	G	h	i	Î	Ï	î	ï				
5	J	K	L	5	J	k	l								
6	M	N	O	6	M	n	o	Ô	Œ	ó	œ				
7	P	Q	R	S	7	p	q	r	s						
8	T	U	V	8	T	u	v	Ù	Û	Ü	ù	û	Û		
9	W	X	Y	Z	9	w	x	y	z	ÿ	ÿ				
0	«	»	0												

Dialpad Characters — Mexican Spanish

Button	Number of Times Dialpad Button is Pressed														
	1	2	3	4	5	6	7	8	9	10	11	12	13	14	15
1	:	-	/	,	.	;	()	&	+	*	!	?	#	1	
2	A	B	C	2	A	b	c	Á	Á						
3	D	E	F	3	D	e	f	É	é						
4	G	H	I	4	G	h	i	Í	í						
5	J	K	L	5	J	k	l								
6	M	N	O	6	M	n	o	Ñ	Ó	ñ	ó				
7	P	Q	R	S	7	p	q	r	s						
8	T	U	V	8	T	u	v	Ú	Ü	ú	ü				
9	W	X	Y	Z	9	w	x	y	z						
0	í	¿	ª	º	0										

Dialpad Characters — Japanese (Katakana)

Button	Number of Times Dialpad Button is Pressed						
	1	2	3	4	5	6	7
1	A	I	U	E	O	a	1
2	KA	KI	KU	KE	KO	i	2
3	SA	SHI	SU	SE	SO	u	3
4	TA	CHI	TSU	TE	TO	e	4
5	NA	NI	NU	NE	NO	o	5

Dialpad Characters — Japanese (Katakana)

	Number of Times Dialpad Button is Pressed						
6	HA	HI	FU	HE	HO	tsu	6
7	MA	MI	MU	ME	MO	ya	7
8	YA	YU	YO	yu	8		
9	RA	RI	RU	RE	RO	yo	9
0	WA	WO	N	pa	ba	lg	0

Using Programmable Buttons

For quick access, you can assign feature codes, extensions, speed-dial numbers, trunks, or other resources to your programmable buttons. You can then press the programmed buttons to activate features or place calls. See “Default Access Codes” and “Default Feature Codes” on [page 16](#) for code lists. You cannot reprogram the default button assignments. See “Programmable Buttons” on [page 4](#).

To program a button:

1. With the handset on-hook, dial **397**.
2. Press the button that you want to program. If the button is:
 - *not programmed*, UNDEFINED KEY appears.
 - *programmed*, the feature or extension programmed for the button appears.
 - *not programmable*, NON-PROGRAMMABLE KEY appears.
3. Enter the feature code, extension number, station speed-dial number, or system speed-dial number to be assigned to the button. To assign speed-dial numbers to programmable buttons, see “Assigning Speed-Dial Numbers to Programmable Buttons” on [page 40](#).

NOTE

Before or after assigning the speed-dial number to a programmable button, make sure the speed-dial number has either a Station Speed Dial bin or System Speed Dial location assigned to it. For System Speed Dial numbers, numbers are pre-assigned to the System Speed Dial locations (000 to 999 or 0000 to 4999) by your system administrator. Therefore, you just need to choose a System Speed Dial location that you want to use (see “Using System Speed Dial” on [page 26](#) for details). For Station Speed Dial numbers, you must manually store numbers in the Station Speed Dial bins (0 to 9). See “Storing Station Speed-Dial Numbers” on [page 26](#).

After you program a button, you can:

- Press the button to place a call to the assigned extension.
- Press the button and then hang up to transfer a call to the assigned extension. If the call is transferred to voice mail you hear repeating double tones.
- Visually monitor the call activity of the assigned extension if the button you assign has a lamp.

The following table describes the lamp signals and the indicated call activity for a PKM/DSS button (station speed-dials do not show status).

Lamp Signals	Description
Continuously Lit	The extension is busy or off-hook.
Slowly flashing	The extension is in Do-Not-Disturb (DND).
Quickly flashing	The extension has a call ringing in.
Continuously flashing	The extension is causing a “Station Off-Hook” system alarm.

Additional Programmable Buttons

You can also use a PKM (DSS/BLF unit) to add additional programmable buttons to your telephone. You can program buttons the same way as those on the associated telephone as described earlier in this section. Contact your system administrator for details.

Default Access Codes

The following are default system access codes. If your system uses different codes, record the codes in the "New Code" column for reference.

Outside Line Access Codes

Code Type	Code	New Code
Emergency Call	911 (999/112 Europe)	
Outgoing Call (Default)	8	
Select Line Group 1 to 208	92001 to 92208	
Automatic Route Selection	92000	

Extension Numbers

Code Type	Code	New Code
Attendant	0	
Phone Extensions	1000 to 1999	
Hunt Groups	2000 to 2299	

Default Feature Codes

The following table lists default feature codes.² If your system administrator changes any of the default codes, you can record the new codes in the “New Code” column for reference.

NOTE

Most of the following feature codes work when your phone is idle. However, if you are on an active call or if the phone is off-hook, you may need to press ∞ (Special) before you enter the feature code to activate the feature.

To delete the characters entered:

Press **MUTE** to move the cursor to the left and delete the characters entered.

To cancel the feature:

Press *****.

Feature	Page	Code	New Code
Account Code – Follow Calls	29	391	
Account Code – Optional	29	390	
ACD Agent – Log In	61	326	
ACD Agent – Log In or Log Out	61	328	
ACD Agent – Log Out	61	327	
ACD Agent – Wrap-up Terminate	62	329	
Activate Door Relay	19	332	
Agent Help – Reject	63	376	
Agent Help – Request	63	375	
Answer Ringing Call	21	351	
Automatic IC Call Access – On/Off	22	361	
Automatic Trunk Call Access – On/Off	22	360	
Automatic Trunk Answer	35	350	
Background Music – On/Off	10	313	
Barge-in	65	386	
Call Forward – All Calls	35	355	
Call Forward – If Busy	35	357	
Call Forward – If No Answer	35	356	
Call Forward – No Answer/Busy	35	358	
Call Logging	44	333	
Change Language	10	301	
Conference	39	5	
Default Station	19	394	
Directory	28	307	
Display Time And Date	34	300	
Do-Not-Disturb	57	370	

² These features shown may or may not be enabled for your system.

Feature	Page	Code	New Code
Do-Not-Disturb – Cancel	57	371	
Do-Not-Disturb – On/Off	57	372	
Do-Not-Disturb – Override	57	373	
Dynamic Extension Express On	36	363	
Dynamic Extension Express Off	36	362	
Dynamic Extension Express On/Off	36	364	
Dynamic Extension Express Handoff	36	388	
Group Listen	44	312	
Handsfree – On/Off	31	319	
Headset – Off	8	316	
Headset – On	8	315	
Headset – On/Off	8	317	
Hold – Individual	32	336	
Hold – System	32	335	
Hookflash (Recall in Europe)	32	330	
Hot Desk On/Off	58	348	
Hunt Group – Remove	63	322	
Hunt Group – Remove/Replace	63	324	
Hunt Group – Replace	63	323	
LCD Contrast Control	10	303	
Message – Cancel Left Message	56	366	
Message – Delete Message	56	368	
Message – Leave Message	55	367	
Message – Menu	56	365	
Microphone Mute – On/Off	31	314	
Page	59	7	
Page Receive – On/Off	59	325	
Program Buttons	14	397	
Program Station Passcode	51	392	
Programmable Buttons – Return to Default	18	395	
Queue (Callback) Request	23	6	
Record-A-Call	43	385	
Redial	25	380	
Redirect Call	22	331	
Reminder Message	58	305	
Reminder Message – Cancel	58	306	
Remote Programming	51	359	

Feature	Page	Code	New Code
Reverse Transfer (Call Pick-Up)	33	4	
Ring Intercom Always – On/Off	31	377	
Ring Tone Selection	9	398	
Station Monitor	64	321	
Station Speed Dial	26	382	
Station Speed Dial – Programming	26	383	
Steal Call	64	387	
System Forward – Off	35	353	
System Forward – On	35	352	
System Forward – On/Off	35	354	
System Speed Dial	26	381	
Switch Keymap	19	399	
Transfer To Hold	33	346	
Transfer To Ring	33	345	
View Programmable Button Assignments	18	396	

Viewing Button Assignments

You can view programmable button (key) feature assignments.

To view button assignments:

1. With the handset on-hook, dial **396**. PRESS THE KEY TO REVIEW appears.
2. Press any of the feature buttons to display the assignment.
3. Press **#** or  (Speaker) to exit.

Resetting Programmable Buttons

You can reset all buttons (keys) that you have programmed to the default assignments. Resetting the programmable buttons does not reset button assignments programmed by the system administrator.

To reset the feature buttons to the default values:

With the handset on-hook, dial **395**. FEATURE KEYS DEFAULTED appears.

Resetting the Phone to the Default Settings

Resetting the phone to the default settings does the following:

- Returns all volume settings to the default levels. See “Changing Volume Levels” on [page 9](#).
- Cancels Background Music. See “Listening to Background Music” on [page 10](#).
- Cancels Callback (queue) requests. See “Requesting a Callback (Queuing the Phone)” on [page 23](#).
- Restores Handsfree Mode. “Using Handsfree Mode” on [page 31](#).
- Cancels Manual Call Forwarding. See “Manual Call Forwarding” on [page 35](#).
- Cancels System Forwarding. See “System Forwarding” on [page 35](#).
- Cancels Do-Not-Disturb (DND). See “Using Do-Not-Disturb” on [page 57](#).
- Restores Page settings. See “Paging Other System Users” on [page 59](#).
- Resets hunt group calls. See “Hunt Groups” on [page 61](#).

To reset your phone to the default settings:

Dial **394**. STATION DEFAULTED appears.

Switching Keymaps

Keymaps are the default button assignments on your phone. Your system administrator may have programmed an alternate keymap, allowing you to switch between keymap assignments. Contact your system administrator for more information.

To switch between keymaps when your phone is idle:

With the handset on-hook, dial **399**. The display shows either ALTERNATE (or) STANDARD KEYMAP IS ACTIVE.

To switch between keymaps during a call:

Press  (Special), and then dial **399**.

Activating Door Relay

If the Activate Door Relay feature is enabled, you can unlock a door (i.e., “buzz” it open) through your IP phone.

You can enter the Activate Door Relay feature code while idle or while on a call. This allows you to activate the feature while talking to a communications device mounted at the door without first having to hang up. When activated while on a call, the feature will not affect the call in progress other than to show a short confirmation on the display.

You can add the Activate Door Relay feature to a phone keymap button, just like any other station feature.

To unlock a door:

While idle or while on a call, dial **332**. The door is unlocked.

Answering and Placing Calls

The following instructions describe how to answer and place internal and external calls and how to use related features.

NOTE

By default, internal (intercom) calls are assigned to the **IC** button, and external calls are assigned to the **CALL** buttons.

Answering Calls

Your phone may be preset to automatically answer incoming internal calls in Handsfree Mode. See “Using Handsfree Mode” on [page 31](#). After disabling Handsfree Mode, you can use your handset or headset to answer incoming calls.

To answer a call:

Lift the handset, or press  (Speaker) to answer a call while using a headset, or to answer a call in Handsfree Mode.

If you are currently on a call, press the flashing **IC** or **CALL** button to answer a waiting call. See “[Answering Waiting Calls](#)” below.

Answering Waiting Calls

If you receive a call while you are on another call, you hear a “call waiting” tone, the **IC** or **CALL** button flashes, and the display shows the Caller ID information (if available).

To answer a waiting call:

Press the flashing **IC** or **CALL** button. This action hangs up on the connected call and connects you to the waiting call. You can also place the first call on hold before you answer the waiting call. See “Placing Calls On Hold” on [page 32](#).

Using Automatic Call Access

Automatic Call Access connects you to incoming internal or external calls when you pick up the handset or press **■** (Speaker). When Automatic Call Access is turned off, you must press the flashing **IC** or **CALL** button to answer incoming calls.

To use Automatic Call Access for incoming IC calls:

With the handset on-hook, dial **361** to turn on. AUTO IC ACCESS ON appears. Dial **361** to toggle back and turn Automatic Call Access off.

To use Automatic Call Access for incoming external (trunk) calls:

With the handset on-hook, dial **360** to turn Automatic Call Access on for incoming external calls on. AUTO TRNK ACCESS ON appears. Dial **360** to turn Automatic Call Access for incoming external calls off.

Redirecting Calls

You can redirect incoming calls to another extension or external number. You can use the menu buttons to redirect calls to the following destinations:

- **SEND TO V-MAIL:** Sends the call directly to your voice mailbox. You must have a mailbox to use this destination.
- **IC CALL TO DND:** Places your phone in DND Mode and blocks the call. See “Using Do-Not-Disturb” on [page 57](#).
- **SEND TO DEST:** Redirects the call to the extension or phone number entered.

To redirect calls:

1. While a call is ringing, dial **331** or press the menu button as previously described. See “Using Automatic Line Access” on [page 22](#).”
2. If applicable, enter the extension number or press the **Outgoing** button (or **8**), and then enter the external number, or enter the DND code (see [page 57](#)). The call is redirected to the destination specified.

Using Automatic Trunk Answer

You can use Automatic Trunk Answer to answer incoming external calls for other internal parties who are members of an “Answer Access” list.¹ Your system administrator creates Answer Access lists. Contact your system administrator for Answer Access list extensions.

Automatic Trunk Answer answers calls in the order they are received (that is, the first call received by any extension in the Answer Access list is the first one answered).

To use Automatic Trunk Answer:

1. While an incoming external call is ringing at another Answer Access list extension, lift the handset or press **■** (Speaker).
2. Dial **350** or press the flashing **Trunk** *<number>* button.

1. This feature may or may not be enabled for your system.

Placing Calls

The following instructions describe how to place calls and related features.

Placing Emergency Calls

Dial the emergency number (911 U.S. or 999/112 Europe). The system immediately places the emergency call as soon as you dial the number, even if you do not select an outside line.

Placing Internal Calls

Internal calls are calls placed to other extensions in the system. Internal calls are assigned to the Intercom (IC) button on your phone. Contact your system administrator for a list of extension numbers.

To place an internal call:

With or without the handset lifted, dial the extension number. If you enter incorrect digits, you can press the **MUTE** button to move the cursor backward, deleting the last digits entered.

If you are using Handsfree Mode, speak after you hear a double tone.

If there is no answer or if the extension is busy, you can do the following:

- Request a callback (queue). See [“Requesting a Callback \(Queuing the Phone\)”](#) below.
- Camp-on to the busy extension. See [“Using Camp-on”](#) below.
- Use Off-Hook Voice Announce to contact the party. See [“Off-Hook Voice Announce”](#) below.
- Leave a message. See [“Leaving Messages at Other Extensions”](#) on [page 55](#).

Requesting a Callback (Queuing the Phone)

When you request a callback (queue the phone), the system calls you when the extension is available and places a call to the phone.

To request a callback:

If there is no answer or if the extension is busy, press the **QUEUE** menu button or  (Special) followed by **6**, and then hang up. **QUEUE REGISTERED FOR <name>** appears. When the extension becomes available, your extension rings.

To cancel the callback request:

Press the **CANCEL QUEUE** menu button or **6**. **QUEUE REQUEST CANCELED** appears.

Using Camp-on

Camp-on keeps you connected to the called extension until it becomes available. You cannot use Camp-on if the called extension is in DND, or if the call is forwarded to voice mail. See [“Using Do-Not-Disturb”](#) on [page 57](#).

To use Camp-on:

Stay on the line and wait for the extension to become available. Do not hang up. If Camp-on is enabled, you hear Music-on-Hold while you are waiting.

Off-Hook Voice Announce

Off-Hook Voice Announce² allows you to talk to the phone user on his or her handsfree speakerphone, even though the user already has a call in progress on the handset.

NOTE This feature is not available on the 8660 IP Phone.

To use Off-Hook Voice Announce:

Do not hang up. After the busy signals stop, you are automatically connected and may speak. (If you hear music or if the phone is in DND mode, your off-hook voice announce call will not go through.) This feature is not available if your phone has the Ring Intercom Always feature enabled.

Placing External Calls

The following sections describe features used when placing external calls.

To place an external call:

1. Press the **OUTGOING** button, an unlit **CALL** button, or enter the Outgoing Call access code (the default code is **8**).
2. Dial the number.

NOTES

If you cannot place an external call because all outgoing lines are busy, you can request a callback, which prompts the system to contact you when a line becomes available. See “Requesting a Callback (Queuing the Phone)” on [page 23](#).

If you are prompted for an account code (indicated by a single beep), you must enter an account code before you can place your call. See “Using Account Codes” on [page 29](#).

Depending on system configuration, you may also be able to use one of the following methods to select an outgoing line:

- Enter the Select Line Group feature code. The default codes are 92001 to 92208.
- Enter the Automatic Route Selection (ARS) feature code. The default code is 92000.

Contact your system administrator for more information about using Select Line Group or ARS access codes.

2. Applies to 8560 Telephones only. This feature may or may not be enabled for your system.

Redialing a Number

You can quickly redial the last *external* number dialed. Although most phones are programmed to redial the last number dialed, your system administrator can program your phone to redial the last number saved. You cannot redial extension numbers.

To use Redial, do one of the following:

- With or without the handset lifted, press **REDIAL**. The system automatically selects a line and dials the number.
- With or without the handset lifted, press **OUTGOING** or the Outgoing Call menu button and then the REDIAL menu button. The number is dialed.

To use the Last Number Saved feature:

- *To save the last number dialed:* While the phone is idle or while listening to intercom dial tone, press **REDIAL**. LAST OUTSIDE NUMBER SAVED appears.
- *To redial the saved number:* After selecting a line, press **REDIAL**. The number is redialed.

NOTE

If there is no redial number available, the display shows NO NUMBER TO DIAL.



Using Speed Dial

You can use speed dial to quickly dial stored phone numbers. Speed-dial numbers are either stored in the system (System Speed Dial), or in your phone (Station Speed Dial).

Using System Speed Dial

Your system administrator assigns System Speed Dial location numbers, which are available to anyone in the system. Contact your system administrator for more information.

To view or dial System Speed-Dial numbers:

1. Dial **381**. REVIEW SYS SPEED # <code range> appears.
2. Do one of the following:
 - Press  (Up) or  (Down) to scroll through the speed-dial locations.
 - Enter the speed-dial location (**000 to 999** or **0000 to 4999**).
3. Press **#** to dial the number.



Using Station Speed Dial

You can use Station Speed Dial to store phone numbers for your personal use. Other system users do not have access to your Station Speed-Dial numbers.

Storing Station Speed-Dial Numbers

You can store up to 10 Station Speed-Dial numbers.



To store a Station Speed-Dial number:

1. With the handset on-hook, dial **383**. PROGRAM STN SPD (0-9) OR SCROLL appears.
2. Do one of the following:
 - Press  (Up) or  (Down) to scroll through the speed-dial bins.
 - Enter the speed-dial bin (**0 to 9**).
3. Press **#** to select the bin.
4. Enter the name of the speed-dial contact (up to 16 characters). For dialpad character descriptions, see “Using the Dialpad Buttons to Enter Characters” on [page 11](#).
5. Press **#** to save the name.
6. Enter the extension number or external number. If you are storing an external number, enter the Outgoing Call access code (default code is **8**) before you enter the number. Do not use hyphens or colons in stored speed-dial numbers.
7. Press **#** to save the bin. STN SPD BIN # <number> UPDATED appears.

Dialing Station Speed-Dial Numbers

To dial a Station Speed-Dial number:



Do one of the following:

- Dial **382**, and then enter the Station Speed-Dial bin (**0 to 9**). The system dials the number.
- Press  (Up) or  (Down) to scroll through the speed-dial bins, and then press **#** to select the bin and dial the number.

You can also program buttons to dial Station Speed-Dial numbers. See “Assigning Speed-Dial Numbers to Programmable Buttons” on [page 27](#) .

Deleting Station Speed-Dial Entries

To delete a Station Speed-Dial entry:

1. With the handset on-hook, dial **383**. PROGRAM STN SPD (0-9) OR SCROLL appears.
2. Do one of the following:
 - Press  (Up) or  (Down) to scroll through the speed-dial bins.
 - Enter the speed-dial bin (**0 to 9**).

Press **#** or the **ACCEPT** menu button to select the bin.
3. Press **MUTE** repeatedly until the name is erased, and then press **#** or the **ACCEPT** menu button to continue.
4. Press **MUTE** repeatedly until the number is erased, and then press **#** or the **ACCEPT** menu button. STN SPD BIN # <number> UPDATED appears.



Assigning Speed-Dial Numbers to Programmable Buttons

You can assign Station or System Speed-Dial numbers to your programmable buttons.



NOTE

Before or after assigning the speed-dial number to a programmable button, make sure the speed-dial number has either a Station Speed Dial bin or System Speed Dial location assigned to it. For System Speed Dial numbers, numbers are pre-assigned to the System Speed Dial locations (000 to 999 or 0000 to 4999) by your system administrator. Therefore, you just need to choose a System Speed Dial location that you want to use (see “Using System Speed Dial” on [page 26](#) for details). For Station Speed Dial numbers, you must manually store numbers in the Station Speed Dial bins (0 to 9). See “Storing Station Speed-Dial Numbers” on [page 26](#).

To program a Station Speed-Dial button:

1. With the handset on-hook, dial **397**. PRESS THE BUTTON TO PROGRAM appears.
2. Press the feature button that you want to program as a speed-dial button.
3. Dial **382**.
4. Do one of the following:
 - Press  (Up) or  (Down) to scroll through the speed-dial bin.
 - Enter the speed-dial bin (**0 to 9**).

To program a System Speed-Dial button:



1. With the handset on-hook, dial **397**. PRESS THE BUTTON TO PROGRAM appears.
2. Press the feature button that you want to program as a speed-dial button.
3. Dial **381**.
4. Do one of the following:
 - Press  (Up) or  (Down) to scroll through the speed-dial location.
 - Enter the speed-dial location (**000 to 999** or **0000 to 4999**).

Using the Directory

You can use the Directory to find internal or external contacts or find and activate system features. The directory uses Intelligent Directory Search (IDS), which is similar to the “text on 9 keys” (T9) predictive search feature used for mobile phones. The Directory has the following three subdirectories:

- **Intercom:** Find and dial internal numbers.
- **Outside:** Find and dial external numbers listed in the company directory.
- **Feature:** Find and activate system features.



When searching the directory, dialpad buttons can represent several characters, as shown in the following table. As you enter characters, the entries that best match the characters entered appear. The system connects the character sequence to possible directory matches. For example, to find the name “Jones,” dial **56637**.

Button	Characters Represented
0	0
1	1
2	2 A B C a b c Ç â ä à â ç Ä Å á
3	3 D E F d e f é ê ë è É
4	4 G H I g h i î ï í
5	5 J K L j k l
6	6 M N O m n o ô õ ö Õ ó ñ Ñ
7	7 Q P R S q p r s
8	8 T U V t u v ü ú û Ü ú
9	9 W X Y Z w x y z ÿ
 (Up)	Scroll to next entry
 (Down)	Scroll to previous entry
*	Cancel search
#	Activate selection
MUTE	Move the cursor to the left, deleting existing characters

NOTE

Previous versions of your system software may be programmed to use the Basic Search feature. With this feature, you do not have predictive search capabilities, therefore, you may have to enter the complete contact or feature name using the dialpad characters shown on “Using the Dialpad Buttons to Enter Characters” on [page 11](#).

To search for a directory name or feature:

1. Dial **307**, and then press one of the following:
 - **1** for the IC directory.
 - **2** for the Outside directory.
 - **3** for the Feature directory.
 - The Directory menu button (**IC**, **OUTSIDE**, or **FEATURE**).
2. Press the dialpad buttons to enter (up to 20) characters. See the table on [page 28](#) for dialpad button character descriptions.
3. Press  (Up) or  (Down) or the >> (Next) or << (Previous) menu buttons to scroll through the entries.

NOTE

The IC directory may display two similar entries, one without an asterisk and one with an asterisk. The entry without an asterisk is the primary extension. The entry with an asterisk is a secondary extension. See “Using Secondary Extension Buttons” on [page 45](#) for more information about primary and secondary extensions.

4. Press **#** or the menu button next to the entry while the display shows the entry to dial a number or activate a feature code.

Using Account Codes

Account codes record information for telephone record reports. You may be required to enter account codes when placing calls. Contact your system administrator for more information about using account codes.

There are three types of account codes:

- **Standard account codes:** Automatically entered into the telephone record report whenever you place a call.
- **Forced account codes:** Entered before you can place an outside call.
- **Optional account codes:** Entered at any time during a call.

To enter an optional account code:

1. While off-hook, press  (Special), and then dial **390**.
2. Enter the optional account code, and then press **#**.

To set an account code for all calls placed from your phone:

Dial **391** followed by the account code, and then press **#**. ACCOUNT CODE ACCEPTED appears. This code is used for all calls made from your phone until it is disabled.

To disable the code:

Dial **391**, and then press **#**. ACCOUNT CODE CLEARED appears.

Call Features

The following sections describe call-related features.

Using Handsfree Mode

You can use Handsfree Mode to activate the speakerphone.

NOTES

The Ring Intercom Always feature prevents calls from being answered in Handsfree Mode (see the following section).

You cannot use Handsfree Mode if you are using a headset, or if you have more than one phone assigned to an extension number.

To use Handsfree Mode:

With the handset on-hook, dial **319**. HANDSFREE MODE ON appears. Dial **319** again to turn Handsfree Mode off.

Using Ring Intercom Always

If another extension has Handsfree Mode enabled for incoming internal calls (see the previous section), you can use Ring Intercom Always to override Handsfree Mode on the extension, requiring the called party to pick up the handset to answer your call.

To override Handsfree Mode for the current call:

1. Before you enter the extension number, press **#**. RING EXTENSION NUMBER appears.
2. Dial the extension number.

To use Ring Intercom Always to always send non-handsfree calls:

With the handset on-hook, dial **377**. RING IC ALWAYS ON appears. Dial **377** again to turn Rings off.

Using Mute

You can use Mute to temporarily turn off your microphone, preventing the other party on the call from hearing you.

To mute or unmute the microphone:

While on a call, press **MUTE**. MICROPHONE MUTE ON appears. When the microphone is muted, the Mute button lamp is lit. Press the **UNMUTE** menu button or **MUTE** again to unmute the microphone.

Placing Calls On Hold

You can place calls on either Individual Hold or System Hold.

- **Individual Hold:** Places an internal or external call on hold at your phone.
- **System Hold:** Places an external call on hold in the system. You can then pick up the call from any phone that indicates a flashing Call button for the call, including the phone that placed it on hold.

To place a call on Individual Hold:

1. Press  (Hold). ENTER EXTENSION NUMBER appears.
2. Hang up or place another call.



To place an outside call on System Hold:

1. Press  (Special), and then dial **335**. ENTER EXTENSION NUMBER appears.
2. Hang up or place another call.

To place a call on hold and answer a waiting call:

Press  (Hold), and then press the flashing **IC** or **Call** button.

To return to a call that is on hold:

Press  (Hold), and then lift the handset or press  (Speaker). <Caller> WAS HOLDING appears.

Entering a Hookflash

Some telephone companies require you to enter a hookflash (a quick hang up and release) for feature access.

To enter a hookflash:

While off-hook, press  (Special), and then dial **330** or press the **FLASH** menu button.

Transferring Calls

You can transfer calls to other extensions or external numbers. You can also transfer conference calls. See “Transferring a Conference” on [page 39](#) for more information.

NOTE

If your system administrator has enabled Transfer-on-Connect for your phone, you are automatically connected to calls transferred to your extension after the transferring party hangs up. If this option is turned off, you must press a **CALL** button to answer calls transferred to your extension.

Transferring Calls to Other Extensions

To transfer a call to another extension:

1. While on the call, press (TRANSFER), and then enter the extension number.
2. Do one of the following:
 - Wait for an answer, announce the call, and then hang up. If the extension is unavailable, press the flashing **IC** or **CALL** button to return to the caller.
 - Hang up to transfer the call and disconnect the call from your phone.

Transferring Calls to External Numbers

To transfer a call to an external number:

1. While on the call, press (TRANSFER).
2. Press the **OUTGOING** button or the Outgoing Call access code (the default code is **8**) to select an outside line.
3. Dial the phone number.
4. Do one of the following:
 - Wait for an answer, announce the call, and then hang up. If the extension is unavailable, press the flashing **CALL** button to return to the caller.
 - Hang up to transfer the call and disconnect the call from your phone.

Using Reverse Transfer

You can use Reverse Transfer (Call Pick Up) to answer calls that are ringing or holding at other extensions. For example, if you receive a call while you are away from your desk, you can pick up the call from another extension.

To use Reverse Transfer:

1. Lift the handset, and then press **4**. ENTER EXTENSION NUMBER appears.
2. Dial the extension or hunt group number or press a PKM/DSS button where the call is ringing or holding. The call is transferred to the phone you are using and you are connected to the caller. See “Hunt Groups” on [page 61](#) for more information about using hunt groups.

Viewing Your System Information

If you are on a call, you can temporarily view your user information (your user name and your extension number) and the date and time.

To display your user information and the date and time:

Press  (Special), and then dial **300**.

Viewing Caller ID Information

If you are currently connected to an external caller with Caller ID, you can toggle between the caller's name and number. If the name is unavailable, CANNOT ACCESS FEATURE appears.

To show the outside party's name/number:

Press  (Special), and then dial **379**.

Forwarding Calls

You can use Manual Call Forwarding or System Forwarding to forward calls.

Manual Call Forwarding

You can use Manual Call Forwarding to send incoming calls to another extension or external number. The following table describes Manual Call Forwarding options.

Call Forward Feature	Description	Code/Menu Button
Call Forward if No Answer	All incoming calls are forwarded if not answered. (The timer is set by the system administrator.)	356 NO ANSWER
Call Forward If Busy	When your phone is busy, all incoming calls are forwarded without ringing.	357 BUSY
Call Forward If No Answer/Busy	All incoming calls are forwarded if your phone is busy or if you do not answer.	358 NO ANSWER/BUSY

To use Manual Call Forwarding:

1. Press **FWD** and then press one of the menu buttons as described in the table above. ENTER FORWARD DEST appears.
2. Enter the extension number, or press the **OUTGOING** button or the Outgoing access code (default code is **8**), and then dial the telephone number. You can press the **MESSAGE CENTER** menu button to forward calls to the Message Center (voice mailbox)¹. FWD ALL CALLS TO <number> appears.

To cancel a Manual Call Forwarding request:

Do one of the following:

- Press the **FWD** button, and then press  (Speaker), or lift and replace the handset. ANY CALL FORWARD CANCELED appears.
- Or press the **FWD** button, and then press the **FWD OFF** menu button.

System Forwarding

You can use System Forwarding to route calls based on the type of call and the idle or busy status of your phone. You cannot program the System Forward destination. You can only turn it on or off. Contact your system administrator for more information.

To turn System Forwarding on or off:

Dial **354**. SYSTEM FORWARD ON appears. Dial **354** again to turn System Forwarding off.

1. This feature may or may not be enabled for your system.

Using Dynamic Extension Express

When you enable Dynamic Extension Express (DEE) on your IP phone, your incoming calls are automatically routed to one or more preprogrammed associated destinations according to the routing steps programmed for you.

Typically, your desk phone is configured to be your main extension. You may be programmed for up to ten associated destinations including: softphone, home IP phone, voice mail, mobile phone, home phone, desk phone 2, mobile phone 2, softphone 2, home IP phone 2, and home phone 2.

Your desk phone, softphone, home IP phone and voice mail extensions are already programmed in the system, so your system administrator can easily include them in your routing steps. To include your mobile and home phone numbers in your routing steps, you will need to provide these numbers to your system administrator.

To enable Dynamic Extension Express:

Dial **363** or **364**. PERSONAL ROUTING ON appears on the display.

To disable Dynamic Extension Express:

Dial **362** or **364**. PERSONAL ROUTING OFF appears on the display.

To answer a call routed to your mobile or home phone:

1. Answer the call when it rings your phone. After you speak, the Dynamic Extension Express prompt is played.
2. Do one of the following:
 - Press # to accept the call.

NOTE

You do not need to wait for the prompt to accept the call. You can accept the call immediately by pressing the # button.

- Press * to send the call to the voice mailbox associated with your main extension (not your mobile phone or home phone voice mailbox). If you do not have a voice mailbox, the “Press *...” prompt is not played and the call is routed to your main extension.

If you hang up, the call continues to follow your programmed routing steps.

When you enable Dynamic Extension Express, your incoming calls are routed as specified by the routing type programmed for you by your system administrator. The table below provides descriptions for the default routing types.

Routing Type	Description
Mobile Twinning	Calls simultaneously ring your desk phone and mobile phone, before going to voice mail.
Delayed Mobile Twinning	Calls ring your desk phone first, and then ring both your desk phone and mobile phone, before going to voice mail.

Check with your system administrator to see which routing type has been programmed for you. Your administrator can modify these routing types by adding or removing routing steps, adding or removing destinations, and changing the ring timers, if required.

To ensure that calls are routed correctly to your mobile and home phones, inform your system administrator if either of these phone numbers change.

The following call types do not follow Dynamic Extension Express:

- Hunt group calls
- Hunt group announcement/overflow calls
- Transfer recalls, Hold recalls, Conference recalls, and Attendant recalls

NOTE

A recall occurs when a feature cannot be completed or the feature times out, and the call returns to the originating extension. For example, a holding call will recall the extension where it was placed on hold when the hold timer expires.

Using the Handoff - Push/Pull Feature

Dynamic Extension Express also includes the Handoff feature, which includes the following functions:

- **Push:** The Handoff “push” function allows you to move an active call from any of your internal associated destinations (unless that destination is a 5610 Cordless Handset or a UC Express SIP Softphone) to an associated destination without disconnecting audio. The push function is useful if you are leaving the work area, but want to remain connected to an active call.
- **Pull:** The Handoff “pull” function allows you to pull a call that was previously routed to your mobile or home phone back to any of your internal associated destinations (unless that destination is a 5610 Cordless Handset or a UC Express SIP Softphone). The pull function is useful if you answer a call on your mobile phone and then return to your desk.

To use the Dynamic Extension Express – Handoff “push” feature:

1. While on an active call at your phone, press ∞ (Special), and then dial **388**. HANDOFF IN PROGRESS appears on the display and the call rings all of your associated destinations (except voice mail).
2. Answer the call at one of your associated destinations. For mobile and home phones, press # to accept the call.

To use the Dynamic Extension Express – Handoff “pull” feature:

While on an active call on an associated destination device, lift the phone handset and dial **388**. A confirmation tone is played and the call is pulled back to your phone.

NOTE

If you enter the handoff feature code (388) and the display shows NO CALL TO HANDOFF, the call cannot be handed off (see [page 69](#)).

To cancel the Dynamic Extension Express – Handoff feature:

While the handoff is in-progress, press ∞ (Special), and then dial **388**. HANDOFF CANCELLED appears on the display for your main extension.

Receiving Message Waiting Indications

If your main extension receives a message waiting indication (MWI) from voice mail or the system's station messaging feature, the MWI is propagated (as applicable) to your other internal associated destinations. If any of your internal associated destinations responds to the MWI, then the MWI is cleared on all of them. Note that if any destination other than your main extension receives an MWI, it will not propagate to the other internal destinations. The MWI has to originate on your main extension.

If enabled, the system can send a text message to your mobile phone to indicate that your main system extension has received a new station message or voice mail message.

Here is an example of an e-mail message generated by a station message:

You have a message from <Username> at extension <Extension>.

Callback: <Auto Attendant Number>

Here is an example of an e-mail message generated by a voice mail message:

You have a new voice mail message for mailbox number <Mailbox Number>.

Callback: <Voice Mail Notification and Retrieval Number>

You can use the callback number to easily call back into the system and speak to the messaging party or retrieve your voice mail message. Check with your administrator if you would like to take advantage of this feature.

Placing Ad Hoc Conference Calls

You can place a Ad Hoc² conference call with up to three internal or external parties (for a total of four parties, including yourself).

To place a conference call:

1. While on the first call, press the **CNF** button to place the call on hold. CALL NEXT PARTY TO CNF appears.
2. Place a call to the next conference party. For external calls, press the **OUTGOING** button or the Outgoing Call access code (the default code is **8**), and then dial the number.
3. After the party answers, announce the conference, and then press the **CNF** button to place the call on hold. If necessary, repeat this step to add the remaining conference party.
4. Press the **CNF** button again or the **CONNECT TO CNF** menu button to start the conference. CNF IN PROGRESS appears.

Adding a Conference Party

You can add a conference party during the conference.

To add a conference party:

1. Press the **CNF** button or the **ADD PARTY** menu button. This leaves the conference parties connected.
2. Place a call to the party to be added to the conference, and then announce the conference. Press the **CNF** button twice or the **CONNECT TO CNF** menu button to add the party and rejoin the conference.

Transferring a Conference

You can transfer an existing conference to another extension.

To transfer a conference:

1. During the conference, press **TRANSFER**, and then dial the extension number.
2. Announce the conference (if desired), and then hang up. CONFERENCE TFR from <name> appears on the called party's display. The party must then press the flashing **CNF** button to connect to the conference.

Dropping Out of a Conference

You can drop out of a conference and return to the conference later.

To drop out of a conference:

Press the **CNF** button or  (Hold), and then hang up. ENTER EXTENSION NUMBER appears. This removes you from the conference but leaves the other parties connected.

To return to the conference:

Press the flashing **CALL** button. CONFERENCE WAS HOLDING appears, and you are reconnected to the conference.

2. The traditional conferencing feature that has always been available on the 5000 CP has been renamed as Ad Hoc Conferencing to differentiate it from the Meet-Me Conferencing feature introduced in v5.0 (see [page 41](#)).

Ending a Conference and Placing all Parties on Hold

You can end a conference and place all conference parties on Individual Hold, allowing you to toggle between the held parties and speak to one party at a time.

To end a conference and place all parties on Individual Hold:

Press the **CNF** button, and then press  (Hold). CONFERENCE PARTIES ON HOLD appears.

To toggle between the held callers:

Press  (Hold) twice for internal parties or the applicable **CALL** button for external parties.

Using Meet-Me Conferencing

The Meet-Me Conferencing feature allows up to eight internal and/or external callers to dial into a conference instead of being manually added by an internal user, as is the case when using the system's traditional "ad hoc" conferencing method. (See [page 39](#) for details on using the traditional Ad Hoc Conferencing method.)

Note that unlike an Ad Hoc Conference, a Meet-Me Conference can consist entirely of outside parties; an internal system user does not have to be present. Also note that the traditional Ad Hoc Conferencing feature is still available for use even when Meet-Conferencing is licensed and enabled. Both conferencing types are available for use as needed.

Many existing system features that work with the traditional Ad Hoc Conferencing method (such as Record-A-Call, transferring a conference, placing a conference on hold, etc.) also work with the Meet-Me Conferencing method.

Conference Assistant

Conference Assistant is a voice-guided application that allows you to initiate or join a Meet-Me Conference by dialing the extension number assigned to the Conference Assistant and then entering the proper access code. If you enter an invalid access code, the Conference Assistant prompts you to try again. The Conference Assistant also lets you know if there are no conferencing circuits available or if the conference is already at capacity.

Access Codes

If Meet-Me Conferencing is enabled for your system, you have the ability to initiate or join a Meet-Me Conference by dialing the Conference Assistant and entering a valid access code. Access codes are typically generated to match each user's extension number, so that each user has their own personal access code for establishing Meet-Me Conferences.

In addition to the personal access code that may match your extension, you can also use the Configuration Assistant application to create conferences with unique system-generated access codes. (See [page 47](#) for details.)

Setting Up a Meet-Me Conference

You can set up a Meet-Me Conference using either your personal access code or a system-generated access code. (See the previous section for more information on access codes.)

To set up a Meet-Me Conference using a personal access code:

1. Tell all intended conference participants to call the Conference Assistant at an agreed-upon time and use your extension number as the access code to join the conference.
2. Follow the instructions for "Joining a Meet-Me Conference" on [page 42](#).

To set up a Meet-Me Conference using a system-generated access code:

1. Generate a Meet-Me Conference access code through the Configuration Assistant application (see [page 50](#)).
2. Tell all intended conference participants to call the Conference Assistant at an agreed-upon time and use the system-generated number as the access code to join the conference.
3. Follow the instructions for "Joining a Meet-Me Conference" on [page 42](#).

Joining a Meet-Me Conference

You can join a conference with up to seven internal and/or external parties (for a total of eight parties, including yourself).

To join a Meet-Me Conference:

1. Dial (or ask to be transferred to) the Conference Assistant extension number. (See your administrator if you do not know the extension number.) You hear: "Welcome to the Conference Assistant. Enter an access code, and then press Pound (#). To cancel, press Star (*)."
2. Enter the appropriate access code for the Meet-Me Conference you wish to join (see "Access Codes" on [page 41](#)). Note the following:
 - If you enter an invalid access code, the Conference Assistant prompts you to try again.
 - If there are no conferencing resources available, or if the maximum number of allowed parties has already been reached, you hear: "All circuits are busy. Please try again later." Hang up and try again later.
3. Once connected, you can talk with other parties who join the conference. (Your phone shows the name of the conference [if available], the total conference duration, and the number of parties connected to the conference.) Note the following:
 - If you are the first person in the conference, you hear: "You are the first person in this conference. Please stay on the line." You then hear music until another caller joins the conference or you hang up.
 - As other parties join or leave the conference, you hear a tone to signal the change.
 - If the conference contains only external callers, the Conference Assistant will prompt the participants to extend the conference after a period time. If no one presses a digit to extend the conference, the system terminates the conference.

Dropping Out of a Meet-Me Conference

You can leave a conference and still leave the other parties connected.

To exit a Meet-Me Conference:

Hang up. The other parties in the conference remain connected.

Putting a Meet-Me Conference on Hold

You can put a conference on hold at your phone (the other parties remain connected) and then later return to the conference.

To put a Meet-Me Conference on Hold:

During the conference, press the **Hold** button.

To return to the Meet-Me Conference:

Lift the handset or press the **Speaker** button, and then press the **Hold** button.

Transferring a Meet-Me Conference

You can remove yourself from a conference and transfer it to another party.

To transfer a Meet-Me Conference to another extension:

1. During the conference, press the **Transfer** button, and then dial the extension number.
2. Announce the conference (if desired), and then hang up. CONFERENCE TFR from <name> appears on the called party's display.

Using Record-A-Call

You can use Record-A-Call to record an ongoing call as a mailbox message.³ You can then retrieve the message from your voice mailbox. The Record-A-Call feature stays active after the other party hangs up, so you can add to the recorded call with your own message.

NOTE Record-A-Call is not supported on peer-to-peer (P2P) calls. Contact your system administrator for more information.

To use Record-A-Call:

1. While on a call, press ∞ (Special), and then dial **385** or press the **RECORD-A-CALL** menu button. REQUESTING RECORD-A-CALL appears.
2. Enter the voice mailbox number where you want the recording to be saved. RECORD-A-CALL IN PROGRESS appears, and both you and the calling party hear a confirmation tone (if enabled).

NOTE If your system administrator assigns the Record-a-Call voice mailbox destination, you do not need to enter the voice mailbox number.

To stop Record-A-Call:

Do one of the following:



- Press ∞ (Special), and then dial **385**.
- Press the **CANCEL RECORDING** menu button.
- Hang up.

³ This feature may or may not be enabled for your system.

Using Group Listen

You can use Group Listen to activate the speaker while you use the handset or headset to continue speaking. This allows other people to hear the other party on the call while the other party can only hear you (through the handset microphone). You cannot use Group Listen in Handsfree Mode.

NOTE

If are using the handset, the  (SPEAKER) button lamp is unlit, even though the speaker is on. However, if you are using a headset, the  (SPEAKER) button lamp is lit. If you press  (SPEAKER) while on either the handset or headset you disconnect the call.

To use Group Listen:

While on a call, press  (Special), and then dial **312**. GROUP LISTEN ON appears, and you hear a confirmation tone. The other party does not hear the confirmation tone. Dial **312** again to turn Group Listen off.



Using Call Logging

Your call logs are records of your most recent missed, received, and dialed calls. A maximum of 20 entries are stored in each call log.⁴

You can use Call Logging to:

- View recent call activity.
- View caller ID information.
- Return or redial calls.

To use Call Logging:

1. Dial **333** or the **LOGS** menu button.
2. Select one of the following options:
 - Press **1** (MISS) or the **MISSED CALLS** menu button for missed calls.
 - Press **2** (RCV) or the **RECEIVED CALLS** menu button for received calls.
 - Press **3** (DL) or the **DIALED CALLS** menu button for dialed calls.
 - Press **4** (CLR) or the **CLEAR LOGS** menu button to clear all entries.
3. Press  (Up) or  (Down) or the **>>** (Next) or **<<** (Previous) menu buttons to scroll through the entries.

The display shows the party's name and the extension or outside number (if available) and the date and time.

If no Caller ID information is available, UNKNOWN CALLER appears.

To return a call or redial a number listed in a call log:

Press **#** or the **CALL NOW** menu button while the display shows the number.

To delete individual call log entries:

Press **0** or the **DELETE** menu button to delete the displayed entry, or press the **DEL ALL** menu button to delete all entries in the current call log.

4. This feature may or may not be enabled for your system.

Using Secondary Extension Buttons

You can use programmable buttons as Secondary Extension buttons.⁵ Secondary Extension buttons are assigned to other extensions in the system (primary extensions). Because Secondary Extension buttons are programmed by the system administrator, you cannot change the buttons (for example, assign features to the buttons).

When programmed, you can use Secondary Extension buttons to:

- Place an internal call to the primary extension.
- View the call activity at the primary extension.
- Transfer calls to the primary extension.
- Answer a call that is ringing or holding on any **CALL** button at the primary extension.

NOTES

Unless internal calls are set up by the system administrator to use **CALL** buttons, you cannot use Secondary Extension buttons to answer ringing or holding internal calls received by the primary extension.

You can use Secondary Extension buttons to notify you when a given number of calls are waiting at the primary extension.

If a Secondary Extension button is flashing (the primary extension has an incoming call), you can press # before pressing the flashing Secondary Extension button to call the primary extension and not answer the incoming call.

5. Secondary Extension buttons must be programmed by your system administrator.

Using Hot Desking

The Hot Desking feature allows users to share phones or temporarily move to other phones and yet maintain their personal identity and preferred phone configuration settings.

If your administrator has set you up with a Hot Desking Profile, you can log on to any Hot Desk-enabled base phone using the Hot Desk feature code (default is 348), your assigned Hot Desk Profile extension number, and your assigned Hot Desk Profile passcode. The system will then apply your phone profile – phone settings such as extension (intercom directory) number, class-of-service, language, programmable buttons, etc. – to the phone.

To log on to a Hot Desk-enabled base phone:

1. At a Hot Desk-enabled base phone, do one of the following:
 - Press the Hot Desk feature button (if one is programmed on the phone).
 - Press the LOGIN menu button (on six-line display phones).
 - Dial **348**.

Display phones show ENTER HOT DESK EXTENSION.

2. Dial your assigned Hot Desk extension number. Display phones show ENTER PASSCODE.
3. Dial your assigned Hot Desk passcode. Display phones show HOT DESK SESSION ACTIVATED for five seconds.

To log off of a Hot Desk session:

Do one of the following:

- Press the Hot Desk feature button (if one is programmed on the phone).
- Press the LOGOUT menu button (on six-line display phones).
- Dial **348**.

Display phones show HOT DESK SESSION TERMINATED for five seconds.

If you forget to log off and then attempt to log on elsewhere, the system automatically logs you off of the original phone so that you can log on to the new phone.

Using Configuration Assistant

If Configuration Assistant is enabled for your system, you can access this voice guided configuration portal that provides easy-to-use, remote access to the following phone configuration options:

- Dynamic Extension Express (see [page 48](#))
- DND (see [page 49](#))
- Manual Call Forwarding (see [page 49](#))
- Meet-Me Conferencing (see [page 50](#))

NOTE

You need a Configuration Assistant extension number to use this feature. Contact your system administrator for more information.

Changing Your Station Passcode

Before using Configuration Assistant, Mitel recommends that you change your default station (phone) passcode to something more secure.

To change your station passcode:

1. Dial **392**. ENTER PASSCODE appears.
2. Enter your current passcode (the default passcode is your extension number), followed by **#**. CHANGE PASSCODE TO appears.
3. Enter the new passcode followed by **#**. VERIFY PASSCODE appears.
4. Enter the new passcode again followed by **#**. DATABASE UPDATED appears.

To change the passcode from another phone, see “Changing Your Station Passcode” on [page 53](#).

Accessing Configuration Assistant

Follow the instructions below to access Configuration Assistant.

To access Configuration Assistant:

1. Access the Configuration Assistant extension number from inside or outside the system by:
 - dialing it from any phone in the system.
 - being transferred to it.
 - dialing it from automated attendant, voice mail, or DISA.
2. Do one of the following:
 - If calling from your main desktop phone, proceed to step 3..
 - If calling from someone else's main desktop phone that is designated as a Configuration Assistant user, press the Star button (*), and then enter your extension number.
 - If calling from a phone that is not designated as a Configuration Assistant user, enter your extension number.
 - If transferred to Configuration Assistant or if calling Configuration Assistant from outside the system, enter your extension number.
3. Enter your station passcode, and then press #. You may now change the settings for any of the following features:
 - Dynamic Extension Express (see below)
 - DND (see [page 49](#))
 - Manual Call Forwarding (see [page 49](#))
 - Meet-Me Conferencing (see [page 50](#))

Changing the Dynamic Extension Express Settings

NOTE

This feature is available only if the authenticated extension is identified as a Dynamic Extension Express (DEE) user. See "Using Dynamic Extension Express" on [page 36](#) for more information.

To change the DDE settings using Configuration Assistant:

1. Access Configuration Assistant as described in "Accessing Configuration Assistant" on [page 48](#).
2. Follow the voice prompts to change your DEE status (on or off) or program a mobile phone number. When this option is selected, Configuration Assistant first states whether DEE is currently enabled or not (for example, "Dynamic extension is enabled"), and then offers the following DEE functions:
 - Enable (only if DEE is disabled)
 - Disable (only if DEE is enabled)
 - Program mobile phone number [you do not have to enter the Outgoing feature code (8)]
3. Hang up, or press the Star button (*) to return to the main menu.

Changing the DND Settings

See “Using Do-Not-Disturb (DND)” on [page 69](#) for more information about using DND.

To change the DND settings using Configuration Assistant:

1. Access Configuration Assistant as described in “Accessing Configuration Assistant” on [page 48](#).
2. Follow the voice prompts to change your DND status (on or off). There is no option to provide a specific DND status message. When this option is selected, Configuration Assistant first states whether DND is currently enabled or not (for example, “Do-Not-Disturb is currently disabled”), and then offers the following DND functions:
 - Enable (only if DND is disabled)
 - Disable (only if DND is enabled)
3. Hang up, or press the Star button (*) to return to the main menu.

Changing the Manual Call Forwarding Settings

See “Manual Call Forwarding” on [page 35](#) for more information about Manual Call Forwarding.

To change the Manual Call Forwarding settings using Configuration Assistant:

1. Access Configuration Assistant as described in “Accessing Configuration Assistant” on [page 48](#).
2. Follow the voice prompts to change your manual call forwarding status (on or off). There is no option to provide a specific call forwarding condition, such as no answer or busy. When this option is selected, Configuration Assistant first states whether call forwarding is currently enabled or not (for example, “Call Forwarding is enabled”) and then offers the following forwarding functions:
 - Forward calls to voice mail
 - Forward calls to an internal extension number
 - Forward calls to an external phone number [you do not have to enter the Outgoing feature code (8)]
 - Disable (only if Call Forwarding is enabled)
3. Hang up, or press the Star button (*) to return to the main menu.

Managing Meet-Me Conferencing Access Codes

See “Using Record-A-Call” on [page 43](#) for more information about Meet-Me Conferencing.

NOTES

This feature is available only if Meet-Me Conferencing is enabled on your phone system.

While using Configuration Assistant options, you can press the Star button (*) any time you wish to cancel the current operation and return to the main menu.

To create a new Meet-Me Conference access code:

1. Access Configuration Assistant as described in your existing phone user guide.
2. Follow the voice prompts to select the conference option, and then select the option to create a new conference access code. Configuration Assistant states your new access code.
3. Hang up, or press * to return to the main menu.

To delete an existing Meet-Me Conference access code:

1. Access Configuration Assistant as described in your existing phone user guide.
2. Follow the voice prompts to select the conference option, and then select the option to delete an existing conference access code. Configuration Assistant prompts you for the access code you wish to delete.
3. Enter the access code, and then press #. If you enter an access code that does not exist, Configuration Assistant prompts you to enter another access code.
4. Hang up, or press * to return to the main menu.

To list all of your existing Meet-Me Conference access codes:

1. Access Configuration Assistant as described in your existing phone user guide.
2. Follow the voice prompts to select the conference option, and then select the option to list your conference access codes. Configuration Assistant first states the number of access code you have and then states all of your existing access codes.
3. Hang up, or press * to return to the main menu.

To send yourself an e-mail message listing all of your existing conference access codes:

1. Access Configuration Assistant as described in your existing phone user guide.
2. Follow the voice prompts to select the conference option, and then select the option to e-mail yourself a list of your existing access codes. You should soon receive an e-mail message that lists all of your existing access codes, including the code number, code name, and when the code was last used.
3. Hang up, or press * to return to the main menu.

NOTE

If you do not have an e-mail address configured in the phone system database, then this option is not provided. Check with your administrator if you would like to take advantage of this feature.

Using Remote Programming

If the Configuration Assistant feature is enabled for your system, Mitel recommends that you use Configuration Assistant instead of the Remote Programming feature described in this section. Configuration Assistant offers an enhanced, voice guided configuration portal that provides easy-to-use, remote access to the Call Forwarding, Dynamic Extension Express, and DND features. See [page 47](#) for using Configuration Assistant.

To use Remote Programming to access these features from another system phone or an external phone, follow the instructions in this section.⁶

NOTE

A Direct Inward System Access (DISA) number is required to use Remote Programming from an external phone. Contact your system administrator for more information.

Changing the Dynamic Extension Express Settings

See “Using Dynamic Extension Express” on [page 36](#) for more information about Dynamic Extension Express.

To enable Dynamic Extension Express using Remote Programming:

1. Do one of the following:
 - Call your DISA number (provided by the system administrator). If necessary, enter your DISA security code.
 - Use any phone on the system.
2. Dial **359**.
3. Enter your extension number.
4. Enter your station passcode followed by #. See [page 47](#) for details on setting up a station passcode for your extension.
5. Dial **363** (Dynamic Extension Express On).

To disable Dynamic Extension Express using Remote Programming:

Follow steps 1. - 4. above, dial **362** (Dynamic Extension Express Off), and then hang up.

⁶ This feature may or may not be enabled for your system.

Changing the DND Settings

See “Using Do-Not-Disturb” on [page 57](#) for more information about using DND.

To turn on DND using Remote Programming:

1. Do one of the following:
 - Call your DISA number (provided by your system administrator). If necessary, enter your DISA security code.
 - Use any phone on the system.
2. Dial **359**.
3. Enter your extension number.
4. Enter your station passcode followed by **#**. See [page 47](#) for details on setting up a station passcode for your extension.
5. Dial **370**.
6. Enter the DND message number (01 to 20), and then enter the second-line message text (if applicable).

To turn off DND using Remote Programming:

Follow steps 1 through 4 above, and then dial **371**.

Changing the Manual Call Forwarding Settings

See “Manual Call Forwarding” on [page 35](#) for more information about Manual Call Forwarding.

To turn on Manual Call Forwarding using Remote Programming:

1. Do one of the following:
 - Call your DISA number (provided by your system administrator). If necessary, enter your DISA security code.
 - Use any phone on the system.
2. Dial **359**.
3. Enter your extension number.
4. Enter your station passcode followed by **#**. See [page 47](#) for details on setting up a station passcode for your extension.
5. Dial one of the following Call Forwarding feature codes:
 - **355** (All)
 - **356** (No answer)
 - **357** (Busy)
 - **358** (No Answer/Busy)
6. Enter either an extension number or **8** followed by a phone number.

To turn off Call Forwarding using Remote Programming:

Dial **355**, and then hang up.

Changing Your Station Passcode

You can use Remote Programming to change the station (phone) passcode. See [page 47](#) for details on setting up a station passcode for your extension.

To change your station passcode using Remote Programming:

1. Do one of the following:
 - Call your DISA number (provided by your system administrator). If necessary, enter your DISA security code.
 - Use any phone on the system.
2. Dial **359**.
3. Enter your extension number.
4. Enter your station passcode followed by **#**.
5. Dial **392**.
6. Enter the new passcode followed by **#**.
7. Enter the new passcode again followed by **#**.

Messages

The following sections describe how to use system messaging features, including:

- **Inter-station messages:** Inter-station messages are alerts sent to your phone by other internal parties, notifying you to contact the party who left the message. The Message button and Message Indicator lamp notify you of the new message. You can then either delete the message or reply to the message, which automatically places a call to the party who left the message.
- **Do-Not-Disturb (DND) messages:** Messages that other internal parties see when your phone is in DND. See “Using Do-Not-Disturb” on [page 57](#).
- **Reminder messages:** Messages that you can use to notify yourself of upcoming appointments, meetings, and so on. See “Using Reminder Messages” on [page 58](#).
- **Pages:** Announcements sent over phone speakers or external speakers. See “Paging Other System Users” on [page 59](#).
- **Voice messages:** System voice mail messages.

NOTE

Because a variety of voice mail products work with the 5000 CP, this guide does not include voice mail instructions. For voice mail instructions, refer to the voice mail user guide for your system. For example, refer to the *Enterprise Messaging, Unified Voice Messaging, and Embedded Voice Mail Card User Guide*, part number 835.3205, or the *Mitel NuPoint Unified Messaging User Guide* (on the [Mitel Web site](http://edocs.mitel.com) (<http://edocs.mitel.com>)). Contact your system administrator for more information about your voice mail system.

Leaving Messages at Other Extensions

You can leave inter-station or voice messages for other internal parties.

To leave an inter-station or voice mail message for a busy IC extension:

1. Press **MSG** or the **LEAVE MESSAGE** menu button. HANG UP OR WAIT FOR MSG CENTER appears.
2. Do one of the following:
 - Hang up to leave an inter-station message. MESSAGE LEFT FOR <name> appears.
 - Stay on the line to connect to the message center (usually voice mail).

To leave an inter-station message without placing an internal call:

1. Dial **367** (Leave Message), or press **MSG** and then press the **LEAVE MESSAGE** menu button. LEAVE MESSAGE ON EXTENSION appears.
2. Enter the extension number. MESSAGE LEFT FOR <name> appears.

Viewing and Responding to Messages

When you have waiting messages, the **MSG** button and Message Indicator lamp are lit. The display shows the number of waiting messages.

The display shows new messages as follows:

- Inter-station messages sent by other internal parties are indicated by the party's programmed user name.
- Voice messages are indicated by FROM MBOX <your extension number>.

To view or respond to messages:

1. With the handset on-hook, press the **MSG** button. Messages are displayed as first in/first out. If there is more than one message, you can repeatedly press the **MSG** button or the **NEXT** and **PREVIOUS** menu buttons to scroll through the messages.
2. When the desired message is displayed, press # or lift the handset for privacy, and then press # or the **Reply** menu button to respond. (If your handset is off-hook and you press the **MSG** button, you automatically place a call to the party or message center that left the message.)

Canceling Messages Left at Other Extensions

You can cancel messages left at other extensions.

To cancel a message left at another extension:

1. Dial **366** or press **MSG**, and then press the **CANCEL MESSAGE** menu button. CANCEL MESSAGE ON EXT # appears.
2. Enter the extension number where you left the message. MESSAGE CANCELED FOR <name> appears.

Deleting Waiting Inter-Station Messages

You can delete waiting inter-station messages.

NOTE To delete waiting voice messages, you must connect to your voice mailbox.

To delete waiting inter-station messages:

1. Press **MSG** or the **VIEW MESSAGE** menu button. MSG <message information> appears.
2. Press * or the **DELETE** menu button to delete the displayed message.



Using Do-Not-Disturb

You can use Do-Not-Disturb (DND) to stop calls and pages to your extension. When activated, internal calling parties see your selected DND message. DND does not block queue callbacks, recalls, and incoming external calls. The following table shows the 20 default DND messages. If your system administrator changes your DND messages, you can record the new messages in the “New Message” column for reference.

Code	Default Message	New Message	Code	Default Message	New Message
01	Do-Not-Disturb		11	Out of Town 'Til	
02	Leave a Message		12	Out of Office	
03	In Meeting Until		13	Out Until	
04	In Meeting		14	With a Client	
05	On Vacation/ Holiday 'Til		15	With a Guest	
06	On Vacation/ Holiday		16	Unavailable	
07	Call Me At		17	In Conference	
08	At the Doctor		18	Away from Desk	
09	On a Trip		19	Gone Home	
10	On Break		20	Out to Lunch	

You can enter a second line of text (up to 20 characters) for DND messages. For example, if you select IN MEETING UNTIL, you can enter “3:30” on the second line. When other internal parties try to call you, their displays show “IN MEETING UNTIL 3:30.”

To turn on DND:

1. Press the **DND** button. SELECT DND MSG # (01-20) appears.
2. Do one of the following:
 - Press  (Up) or  (Down) to scroll through the messages.
 - Enter the two-digit number for the DND message from the preceding table.
 - Press the **SCROLL** menu button, and then press the **PREVIOUS** or **NEXT** menu buttons to scroll through the list.
3. Press **#** or the **ACCEPT** menu button message.
4. If applicable, enter the additional text for the DND description. See “Using the Dialpad Buttons to Enter Characters” on [page 11](#) for dialpad character descriptions.
5. Press  (Speaker) or the **ACCEPT** menu button, or lift and replace the handset.

To turn off DND:

Press the **DND** menu button, and then press **DND OFF. DO-NOT-DISTURB OFF** appears.

Using Reminder Messages

You can use Reminder messages to alert you at a selected time, up to 24 hours in advance. At the selected time, the Reminder message signals you with eight short tones and your display shows the message, even if you are on a call.

The following table shows the 20 default Reminder messages. If your system administrator changes your Reminder messages, you can record the new messages in the “New Message” column for reference.

Code	Default Message	New Message	Code	Default Message	New Message
01	Meeting		11	Call Engineering	
02	Staff Meeting		12	Call Marketing	
03	Sales Meeting		13	Call Accounting	
04	Cancel Meeting		14	Cancel DND	
05	Appointment		15	Cancel Call Fwd	
06	Place Call		16	Take Medication	
07	Call Client		17	Make Reservation	
08	Call Customer		18	Review Schedule	
09	Call Home		19	Lunch	
10	Call Corporate		20	Reminder	

To set a Reminder message:

1. With the handset on-hook, dial **305**. SELECT REMINDER MESSAGE # (01-20) appears.
2. Do one of the following:
 - Press (Up) or (Down) to scroll through the messages.
 - Enter the two-digit number for the Reminder message from the preceding table.
 - Press the **SCROLL** menu button, and then press the **PREVIOUS** or **NEXT** menu buttons to scroll through the list.
3. Press # or the **ACCEPT** menu button to select the message.
4. Enter the time you wish to receive the message in hours and minutes (for example, **0900** or **900** for **9:00**), and then press #. The display shows the Reminder message state.

If your system is set for 24-hour format, enter the applicable time (1400 = 2:00 P.M.).

*If your system is set for 12-hour format, press **1** for A.M. or **2** for P.M.*

To cancel all Reminder message requests:

With the handset on-hook, dial **306**. REMINDER MSGS CANCELED appears.

To clear a received Reminder message:

With the handset on-hook, press *****.

Paging Other System Users

You can place page announcements through phone speakers or external speakers (if applicable). Your system may use page zones to prevent announcements from transmitting through every phone in the system. Each page zone contains a different combination of extensions and external paging equipment.

Contact your system administrator for page zone information. You can use the following table to save the page zone information for future reference.

Page Zone Name	Number	Description

Placing a Page Announcement

The following instructions describe how to place a page announcement.

To place a page announcement:

1. Press the **PAGE** button.
2. Enter the page-zone number (**0** to **9**).
3. Wait for the tone, make your announcement, and then hang up.

Enabling or Disabling the Page Feature

You can enable or disable the Page feature for your extension. If your extension is assigned to more than one page zone, the Page on and off feature code enables or disables your extension for all pages zone (you cannot select individual zones).

To enable or disable paging for your phone:

Dial **325** to enable paging. PAGE RECEIVE ON appears. Dial **325** again to disable paging.

Hunt Groups

Hunt groups are groups of internal parties (agents) who share a common (hunt group) extension number. Calls can either be placed to the hunt group (using the hunt group extension number) or to a specific agent (using the agent's extension number). Hunt groups are programmed by the system administrator.

Hunt groups types are either "UCD" or "ACD."

- **UCD Hunt Groups:** Uniform Call Distribution (UCD) agents do not log in to the hunt group to receive calls.
- **ACD Hunt Groups:** Automatic Call Distribution (ACD) agents log in to the ACD hunt group to receive calls. Calls are distributed by either Agent IDs or extensions:
 - *Agent IDs:* Each agent is assigned an Agent ID number for logging in to the hunt group (see the next section). Hunt group calls are distributed to logged-in agents according to their Agent ID number instead of their extension number. Agents can log in to any ACD hunt group phone.
 - *Extensions:* Hunt group members do not use Agent IDs, and calls are distributed to phones where the agents are logged in.

Logging in to ACD Hunt Groups

You must log in to an ACD hunt group to receive hunt group calls. To stop calls, you either log out of the ACD hunt group or divert calls. See "Diverting Hunt Group Calls" on [page 63](#).

NOTES	<p>Only one agent can be logged in to a phone.</p> <p>If the ACD Agent ID Automatic Connect option is enabled for your hunt group and you are using a headset, you are automatically connected to waiting calls when you log in. The first call you receive after you log in rings until you answer it; however, you are automatically connected to subsequent calls.</p>
--------------	---

To log in to or out of all ACD hunt groups in which you are a member:

Dial **328** to log in to ACD hunt groups followed by your Agent ID, if necessary. AGENT LOGGED INTO ALL ACDS appears. Dial **328** again to log out of all ACD hunt groups.

To log in to one or more ACD hunt groups:

1. Dial **326**. The display shows AGENT LOGIN ACD HG #.
2. Do one of the following:
 - Enter the ACD hunt group number.
 - Press **#** to log in to all of your ACD hunt groups.

The display shows AGENT LOGIN AGENT ID.

3. Enter your Agent ID (if applicable), or press **#** if you do not have an agent ID. The display shows the log in status for one or all hunt groups.

Logging out of ACD Hunt Groups

You can log out of all ACD hunt groups at once or log out of each hunt group one at a time.

To log out of one or more ACD hunt group:

Do one of the following:

- Dial **328** to log out of all of your ACD hunt groups. The display shows AGENT LOGGED OUT OF ALL ACDS.
- Dial **327** to log out of one hunt group at a time.

If you were logged in to only one hunt group, the display shows AGENT LOGGED OUT OF HUNT GROUP <number>.

If you were logged in to more than one hunt group, the display shows AGENT LOGOUT HG #. Enter the extension number of the ACD hunt group.

Stopping the ACD Hunt Group Wrap-up Timer

Each time you end an ACD hunt group call, a wrap-up timer starts. The default wrap-up time is 15 seconds. Your system administrator can change the wrap-up timer settings.

Until this timer expires, you will not receive another hunt group call; however, you can stop the wrap-up timer to allow calls to your extension.

To stop the wrap-up timer:

With the handset on-hook, dial **329**. ACD WRAP-UP TERMINATED appears.

Other Hunt Group Features

The following features can be used by ACD or UCD hunt groups.

Requesting Agent Help

You can use Agent Help to request help from a designated “Agent Help Extension” (usually your supervisor) during a call. When your request call rings at the Agent Help Extension, the supervisor can join the call or reject the request.

NOTE Agent Help is not supported on peer-to-peer (P2P) calls. Contact your system administrator for more information.

To use Agent Help:

1. While you are on a hunt group call, press ∞ (Special), and then dial **375**.

NOTE If you hear repeating tones, one of the following has occurred:

- The feature is not available at your phone.
- You already have four parties in your call.
- Not enough system circuits are currently available.
- The Agent Help Extension is in DND.

2. If not preprogrammed, dial the Agent Help extension number.

If the Agent Help Extension accepts the call, AGENT HELP IN PROGRESS appears.

If the Agent Help Extension rejects the call, AGENT HELP REJECTED appears.

Diverting Hunt Group Calls

You can temporarily divert hunt group calls, preventing hunt group calls to your extension.

To divert hunt group calls:

Dial **324** to divert calls. The display shows the feature state DIVERT HUNT GROUP CALLS. Dial **324** again to program your phone to accept calls.

Hunt Group Supervisor Features

The following features can be used by hunt group supervisors only.

Accepting or Rejecting Agent Help Calls

Supervisors can accept or reject Agent Help calls.

To accept an Agent Help request:

Answer as usual. Your microphone is automatically muted.

To reject an Agent Help request:

Dial **376**. AGENT HELP REJECTED appears.

Monitoring Calls

You can use Station Monitor to connect to a hunt-group call and hear both parties, but you cannot be heard by either one. Station Monitor stops if the hunt group member terminates or transfers the call. You can barge-in to or “steal” monitored calls, as described in the following sections. You can also record the call. See “Using Record-A-Call” on [page 43](#) for more information about recording calls.

To use Station Monitor:

Dial **321**, and then enter the extension number. MONITORING EXT <number> appears. Monitored hunt group members may hear an “activation tone” when the feature is activated.

Stealing Hunt Group Calls

While monitoring a hunt group call, you can “steal” the call from the hunt group member, which disconnects the call from the agent and transfers the call to your extension.

To steal a hunt group call:

Dial **387**. CALL STOLEN FROM EXT <number> appears.

Using Barge-in

While monitoring a hunt group call, you can use Barge-in to join the call.

To monitor and/or barge in on a call:

1. **To use the speakerphone:** While on hook, dial **321**. You hear a confirmation tone. ENTER EXT TO MONITOR appears.
To use the handset: Lift the handset, and then dial **321**. You hear a confirmation tone. ENTER EXT TO MONITOR appears.
2. Dial the extension number (or press the lit station speed-dial or PKM button) of the station to be monitored. You are automatically connected to the call. MONITORING (*extension number*) appears.
3. While silent monitoring a call, you have the following options:
 - *To barge in on a call*, dial **386** or press the **BARGE-IN** menu button. BARGE-IN IN PROGRESS appears. While on a call, you can monitor, record, or steal the call by entering the appropriate feature code or by pressing the appropriate menu button.
To return to silent monitoring of the call, dial **386** again or press the **MONITOR** menu button.
To record the call, dial **385** or press the **RECORD CALL** button.
 - *To record a call*, dial **385** or press the **RECORD** menu button. MONITORING (*extension number*) appears. While on a call, you can monitor or steal the call by entering the appropriate feature code or by pressing the appropriate menu button.
To stop recording the call, dial **385** again or press the **STOP RECORDING** menu button.
 - *To steal a call*, dial **387** or press the **STEAL** menu button. CALL STOLEN FROM (*extension number*) appears. The hunt group member's display shows CALL STOLEN BY (*extension number*). After the supervisor steals the call, the call becomes a regular call. While on a call, you can record the call by dialing **385** or by pressing the **RECORD** menu button.
 - *To join and record a call*, dial **386** or press the **JOIN AND RECORD** menu button, and then dial **385**. BARGE-IN IN PROGRESS appears. While on a call, the supervisor can monitor, stop recording, or steal the call by entering the appropriate feature code, or by pressing the appropriate menu button.
To stop recording the call, dial **385** again, or press the **MONITOR** or **STOP RECORDING** menu button.
4. **To terminate any of the features:** *If off hook*, hang up or enter the specific feature code of the feature you want to terminate. *If on hook*, press the **Speaker** button or enter the specific feature code of the feature you want to terminate.

Troubleshooting

The following sections can help you solve problems that you may be experiencing with your phone. Troubleshooting topics include:

- **Contact Information:** Information about system administrator contacts.
- **Error Messages:** Error messages and descriptions.
- **Troubleshooting Tips:** Possible problems and methods to solve them.

Contact Information

Your system administrator can help you with items such as changing your settings or modifying phone features. System administrator duties include:

- Adding new user accounts.
- Setting the date and time.
- Programming System Speed-Dial numbers.
- Making database changes, such as changing user names and extension numbers.

Contact your system administrator with questions that are not covered in this user guide. If you need further assistance, you can find provider information on the [Mitel Web site](http://www.mitel.com) (www.mitel.com). All sales, service, and support are coordinated at the local level.

Error Messages

The following error messages may appear when using your phone.

Message	Reason
CANNOT ACCESS FEATURE	The feature is enabled but other feature-related conditions were not met. Make sure that all feature-related conditions are met and retry.
CANNOT ACCESS RESERVED FEATURE	Your system does not support the feature. Contact your system administrator for more information.
INVALID FEATURE CODE	The feature code entered does not exist. Retry using the correct feature code (see page 16).
INVALID EXTENSION NUMBER	The extension number entered does not exist. Retry using a valid extension number.
NO UPDATE PERFORMED	The feature was not completed or one or more feature conditions were not met.

Troubleshooting Tips

The following table includes troubleshooting tips for phone and system features.

NOTE	You can often correct problems that you may be experiencing by resetting the phone to the default settings. See “Resetting the Phone to the Default Settings” on page 19 .
-------------	--

Problem	Possible Solution
The phone is not working properly.	Contact your system administrator.
I cannot use one or more of the features described in this guide.	The feature may not be enabled. Contact your system administrator for more information.
I cannot program System Speed-Dial numbers.	Your system administrator programs System Speed Dial numbers.
I cannot change the time and date on the phone display.	Your system administrator programs the time and date. Contact your system administrator if you notice that the date and time are incorrect.
I am experiencing audio problems on my phone such as echo, distorted sound, or choppiness.	Contact your system administrator if you are having audio problems.
The name on the display is incorrect	Your system administrator assigns display names.
I cannot use the local telephone company star codes (for example, *82, *69) when I press the Outgoing button or use the Outgoing Call access code (8) when calling an external number.	Rather than pressing the Outgoing button or 8 to access an outside line, you must dial a Select Line Group number before you can use the star codes. For example, if your system is using the default Select Line Group numbers, dial 92001 to access that line. After you have dial tone, you can dial the star code and the number.
I cannot use the Agent Help, Record-a-Call, or Station Monitor features.	If your system uses Peer-to-Peer (P2P) audio, you cannot use these features when you are on a P2P call. Contact your system administrator for more information.
I cannot program a Station Speed Dial number to the button I want.	Before assigning the speed-dial number to a programmable button, you must store the number with either a Station or System Speed Dial bin.

Problem	Possible Solution
<p>When I try to use the Dynamic Extension Express – Handoff feature (388), the display shows NO CALL TO HANDOFF.</p>	<p>The NO CALL TO HANDOFF display indicates that the call cannot be handed off because one of the following may have occurred:</p> <ul style="list-style-type: none"> • You tried to use the Handoff feature on a call that has not been routed by Dynamic Extension Express. • You tried to use the Handoff feature on a call that the system has not yet recognized as a valid call. • You tried to use the Handoff feature on an unsupported extension. The Handoff feature is supported on your main extension only. • You tried to use the Handoff feature on a phantom extension. The Handoff feature is not supported on phantom extensions. • You entered the handoff feature code at the exact time the other party on the call disconnected. • The call was terminated for some reason.

Index

A

- Abbreviations 3
- About Your Phone 2
- Access Codes 41
- Account Codes 29
- Account Codes, using 29
- ACD Hunt Group Wrap-Up Timer, stopping 62
- ACD Hunt Groups
 - logging in 61
 - logging out 62
- Ad Hoc Conference Calls
 - dropping 39
 - ending 40
 - placing 39
 - transferring 39
- Ad Hoc Conference Parties
 - adding 39
 - placing on hold 40
- Additional Programmable Buttons 14
- Agent Help
 - accepting or rejecting 64
 - requesting 63
- Agent, ACD hunt group 61
- Angle, adjusting 9
- Audio Problems 68
- Automatic
 - call access, using 22
 - trunk answer, using 22

B

- Background Music
 - listening 10
- Barge-In, using 65
- Button Assignments, viewing 18
- Buttons 5

C

- Call Forward
 - Manual 35
 - System 35
 - using 35

- Call Logging 44
- Call Logs, using 44
- Callback, requesting (queuing the phone) 23
- Caller ID Information
 - displaying 34
 - viewing 34
- Calls
 - answering 21
 - anwering 21
 - camping-on to phone 23
 - external, placing 24
 - forwarding 35
 - logs, using 44
 - monitoring 64
 - muting the microphone 31
 - phone, queuing for 23
 - picking up (reverse transferring) 33
 - placing 23
 - placing internal (IC) 23
 - recording 43
 - redirecting 22
 - stealing 64
 - transferring 33
 - waiting 21
- Calls On Hold, placing 32
- Calls to External Numbers, transferring 33
- Calls to Other Extensions, transferring 33
- Camp-On, using 23
- Characters, entering dialpad 11
- Codes
 - account 29
 - default system access 15
 - feature, default 16
 - Outgoing Call access 24
- Comfort and Safety Tips 7
- Conference Assistant 41
- Configuration Assistant 47
 - accessing 48
 - DND settings, changing 49
 - manual call forwarding settings, changing 49
 - meet-me conferencing access codes, managing 50
 - station passcode, changing 47
- Connectors, phone 6
- Contact Information 67
- Contrast, changing 10

D

- Default
 - access codes 15
 - feature codes 16
 - settings, returning the phone to 19
 - system access codes 15
- Dialpad
 - buttons 4
 - characters, entering 11
- Dialpad Buttons 4
- Dialpad Buttons to Enter Characters, using 11
- Direct Station Selection/Busy Lamp Field (DSS/BLF) Unit 14, 15
- Directory, using 28
- Display 3
 - contrast, changing 10
 - name, changing 68
- Display Contrast, adjusting 10
- DND Settings, changing 49, 52
- Do-Not-Disturb, using 57
- Door Relay, activating 19
- Dynamic Extension Express 36
 - enabling and disabling 36
 - handoff - push/pull 37
 - message waiting indications, receiving 38
- Dynamic Extension Express Settings, changing 48, 51

E

- Emergency Calls, placing 23
- Error
 - messages 67
 - tones, phone 7
- Error Messages 67
- Extension Numbers 15
- External Calls, placing 24
- External Numbers, redialing 25

F

- Feature
 - buttons 5
 - codes, using 16
- Feature Buttons 5
- Feature Descriptions 3
- Features to Programmable Buttons, using 14

G

- Group Listen, using 44

H

- Handoff - Push/Pull 37
- Handset 3
 - off-hook 7
 - off-hook, on-hook 7
 - on-hook 7
- Handsfree Mode 31
 - overriding 31
 - using 31
- Headset
 - instructions 8
 - using 8
- Headset Instructions 8
- Hold
 - Individual 32
 - System 32
- Hookflash, entering 32
- Hot Desking, using 46
- Hunt Group Calls
 - diverting 63
 - stealing 64
- Hunt Group Calls, diverting 63
- Hunt Group Supervisor Features 64
- Hunt Groups
 - accepting or rejecting Agent Help 64
 - Agent Help, requesting 63
 - agent IDs 61
 - Automatic Call Distribution (ACD) 61
 - Barge-In, using 65
 - calls
 - diverting 63
 - monitoring 64
 - stealing 64
 - logging out 62
 - types 61
 - Uniform Call Distribution (UCD) 61
 - wrap-up timer 62

I

- Individual Hold, using 32
- Internal Calls, placing 23
- Inter-Station Messages, deleting 56
- IP Phone Exceptions 7

K

Keymaps

- changing 19
- switching 19

L

- Language, changing 10
- LCD Contrast, changing 10
- Logs, call 44

M

- Manual Call Forwarding 35
- Manual Call Forwarding Settings, changing 49, 52
- Meet-Me Conferencing 41, 42
 - access codes 41
 - Conference Assistant 41
 - dropping 42
 - putting on hold 42
- Meet-Me Conferencing Access Codes 50
- Meet-Met Conferencing
 - joining 42
 - setting up 41
- Members, hunt group 61
- Menu Buttons 4
- Message Indicator Lamp 4
- Message Waiting Indications, receiving 38
- Messages
 - canceling 56
 - deleting 56
 - Do-Not-Disturb 57
 - error 67
 - leaving 55
 - Messages
 - voice, listening 56
 - pages 59
 - Reminder 58
 - using 55
 - viewing 56
 - viewing and responding 56
- Messages at Other Extensions, leaving 55
- Messages Left at Other Extensions, canceling 56
- Messages, viewing and responding 56
- Microphone, muting 31
- Music, listening 10
- Mute, using 31

N

Numbers

- redialing 25
- redialing external 25

O

- Off-Hook 7
- Off-Hook Voice Announce 24
- On-Hook 7
- Other Hunt Group Features 63
- Out of a Conference, dropping 39
- Outgoing Call Access Code 24
- Outside Line Access Codes 15

P

- Page Announcement, placing 59
- Page Feature, enabling or disabling 59
- Paging
 - enabling or disabling 59
 - other system users 59
 - other system users 59
 - using 59
- Passcode, Remote Programming
 - changing 53
 - entering 47
- Phone
 - blank display 1
 - changing volume levels 9
 - comfort and safety 7
 - connectors 6
 - default settings, returning to 19
 - error tones 7
 - features
 - dialpad buttons 4
 - feature buttons 5
 - menu buttons 4
 - Ring/Message Indicator 4
 - speaker 4
 - ring tone, selecting 9
 - signals 7
 - viewing angle, changing 9
- Phone Connectors 6
- Phone Signals 7
- Phone to the Default Settings, resetting 19
- Programmable Key Module (PKM) 14

Index

Programmable Buttons 4, 14
 porgramming 18
 programming 18
 resetting 18
 using 14
 viewing button assignments 18

R

Record-A-Call, using 43
Reminder Messages, using 58
Remote Programming 51
 change DND settings , using 49, 52
 change the passcode, using 53
 forward calls, using 48, 49, 52
 passcode
 changing 53
 entering 47
Reverse Transfer (Call Pickup), using 33
Ring Intercom Always, using 31
Ring Message Indicator 4
Ring Tone
 changing 9
 selecting 9

S

Secondary Extension Buttons, using 45
Settings, returning to default 19
Signals, phone 7
Silent Messages
 canceling 56
 deleting 56
 leaving 55
Speaker 4
Speaker, external 4
Speakerphone
 description 4
 Group Listen, using 44
 handsfree calls 31
Speed Dial 26
 entries, deleting 27
 Station, using 26
 System, using 26
 using 26

Speed Dial Numbers to Programmable Buttons, assigning 27
STAR Codes, telephone company 68
Station Messages
 replying to 56
 viewing 56
Station Monitor, using 64
Station Passcode, changing 47, 53
Station Speed Dial 26
 numbers
 deleting 27
 dialing 26
 storing 26
 using 26
System
 forwarding 35
 Hold 32
 information, displaying 34
 time and date, setting 68
System Forwarding 35
System Information, viewing 34
System Speed Dial, using 26

T

Telephone, programmable buttons 14
Time and Date, system 68
Tips
 comfort and safety 7
 troubleshooting 68

V

Voice Messages
 deleting 56
 leaving 55
 listening 56
Volume Levels 9
Volume Levels, changing 9

W

Waiting Calls, answering 21
Welcome 1
Wrap-Up Timer, stopping 62

Part No. 550.8113
Issue 15, February 2011



Global Headquarters	U.S.	EMEA	CALA	Asia Pacific
Tel: +1(613) 592-2122 Fax: +1(613) 592-4784	Tel: +1(480) 961-9000 Fax: +1(480) 961-1370	Tel: +44(0)1291-430000 Fax: +44(0)1291-430400	Tel: +1(613) 592-2122 Fax: +1(613) 592-7825	Tel: +61(0) 2 9023 9500 Fax: +61(0) 2 9023 9501

For more information on our worldwide office locations, visit our website at www.mitel.com/offices

THIS DOCUMENT IS PROVIDED TO YOU FOR INFORMATIONAL PURPOSES ONLY. The information furnished in this document, believed by Mitel to be accurate as of the date of its publication, is subject to change without notice. Mitel assumes no responsibility for any errors or omissions in this document and shall have no obligation to you as a result of having made this document available to you or based upon the information it contains.

M MITEL (design) is a registered trademark of Mitel Networks Corporation. All other products and services are the registered trademarks of their respective holders.

© Copyright 2010, Mitel Networks Corporation. All Rights Reserved.

www.mitel.com

